

Low Voltage AC Drives for HVAC Applications

FRENIC-HVAC

Smile to the Environment



H



VAC

High performance drives enabled by the comprehensive use of Fuji Electric Technology.

Easy maintenance for the end-user, ensures safety and protects the environment.

Opens up possibilities for the new generation.

Smile to the Environment

FRENIC-HVAC

~ Energy Saving for the Environment and the Future ~

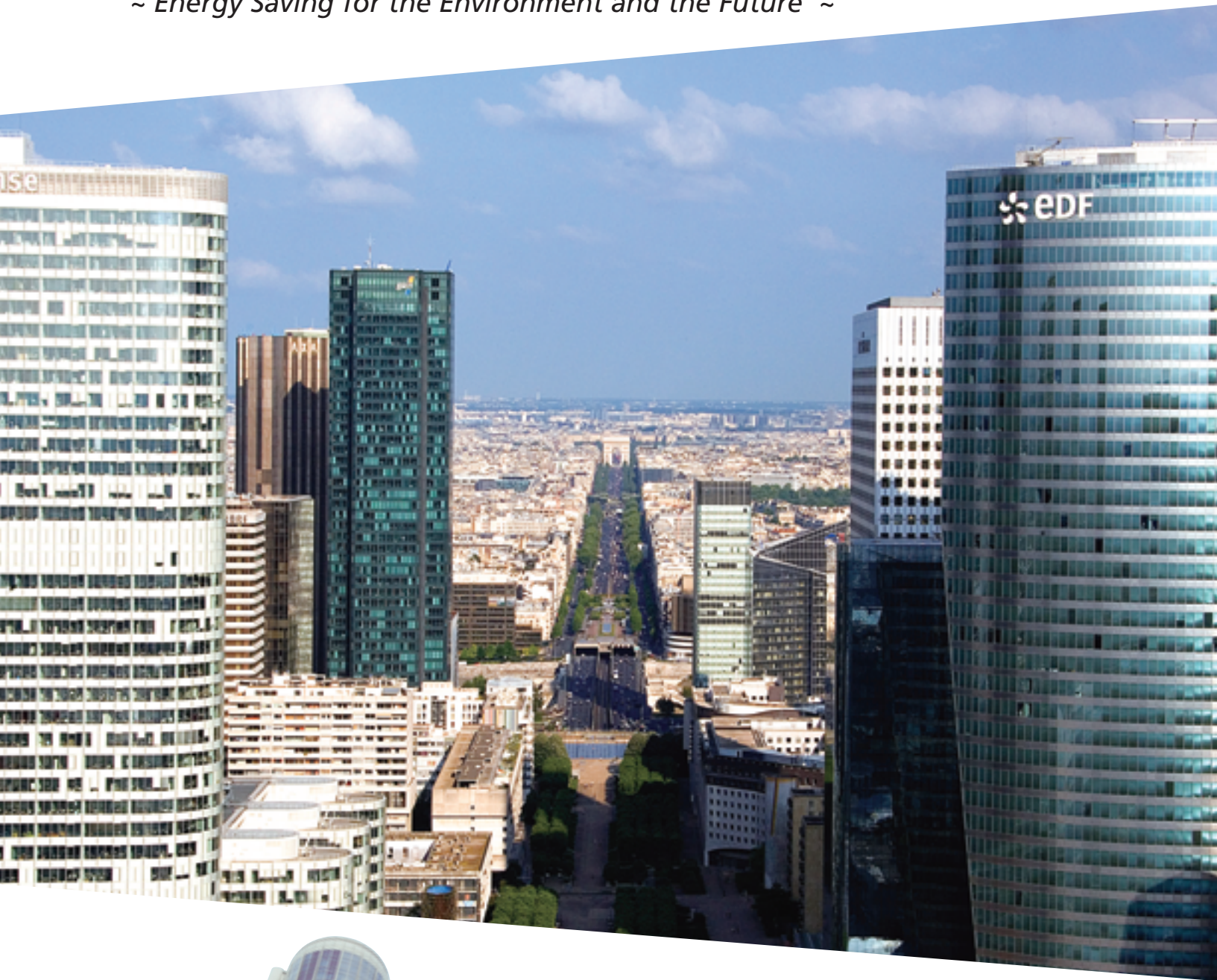

The first slim-type inverter specialized in energy-saving from Fuji Electric. Achieves a great effect on energy-saving for fans and pumps! Contributes drastically to cost reduction by cutting power consumption!

Fuji Electric's inverters save the energy consumed in fans and pumps for HVAC operations and reduce costs.

The FRENIC-HVAC series controls water and air flow rates, pressure, and temperature with the fan and pump optimization.



Contributes to Reducing Global Warming (Environmental Protection) and Achieves with Energy Saving

50% of energy consumption in office buildings is related to air conditioning.

The FRENIC-HVAC series are inverters for HVAC that have key features, functions and performances that offer the optimal thermal environment for the people working in the building by keeping the energy consumption in various devices such as compressor, condenser water pump and AHU to a minimum.

Fuji Electric contributes largely to global environment by realizing carbon dioxide reduction with energy saving by the inverter.

Wide Variation in Model Capacity

FRENIC-HVAC is designed for various type of environments, such as supply voltage, enclosures. The user gets every key features for HVAC market in one unit, such as EMC filter is equipped as standard feature for all models and DCR is equipped in certain capacity range.

Inverter capacity	EMC filter	DC reactor	Enclosure
1 to 60 HP (Three-phase 230V series) 1 to 125 HP (Three-phase 460V series) 1 to 150 HP (Three-phase 575V series)	Built-in	Built-in	IP21/55 NEMA type1 / type12
75 to 125 HP (Three-phase 230V series) 150 to 1000 HP (Three-phase 460V series) 200 to 300 HP (Three-phase 575V series)	Built-in	External	IP00 Open

Optimal Control with Energy-Saving Function

- Linearization function
- Temperature difference constant control and pressure difference constant control
- Energy saving functions including wet-bulb temperature presumption control
- Automatic energy-saving operation

Slim Body

The first slim body design among the Fuji Electric inverters.

The size is the same between UL type1 and type12 (the first in the industry).

Functions Suitable for HVAC Uses

- 4 PID control
- Fire mode (forced operation)
- Pick-up operation function
- Real time clock
- Torque vector control
- Filter clogging prevention function
- Customized logic
- User friendly, useful keypad
- Password function

Stand Alone

- The inverter can be installed independently; there is no control panel is required.



Significant Energy Savings Realized!!

For an air-conditioning heat source system, the quantity of the cooling or heating water fluctuates generally during the seasons or days and nights. Therefore, operations continuing in a water conveyance pressure constant control may lead to high operating pressures on terminals at low operating state. The pump consumes an inefficient electric power for maintaining the high water conveyance pressure.

FRENIC-HVAC inverters can perform an estimated terminal pressure control by linearization function which estimates target pressure from a load flow rate.

It is possible to reduce the inefficient pump power consumption and to achieve energy-savings while maintaining comfortable air conditioning.

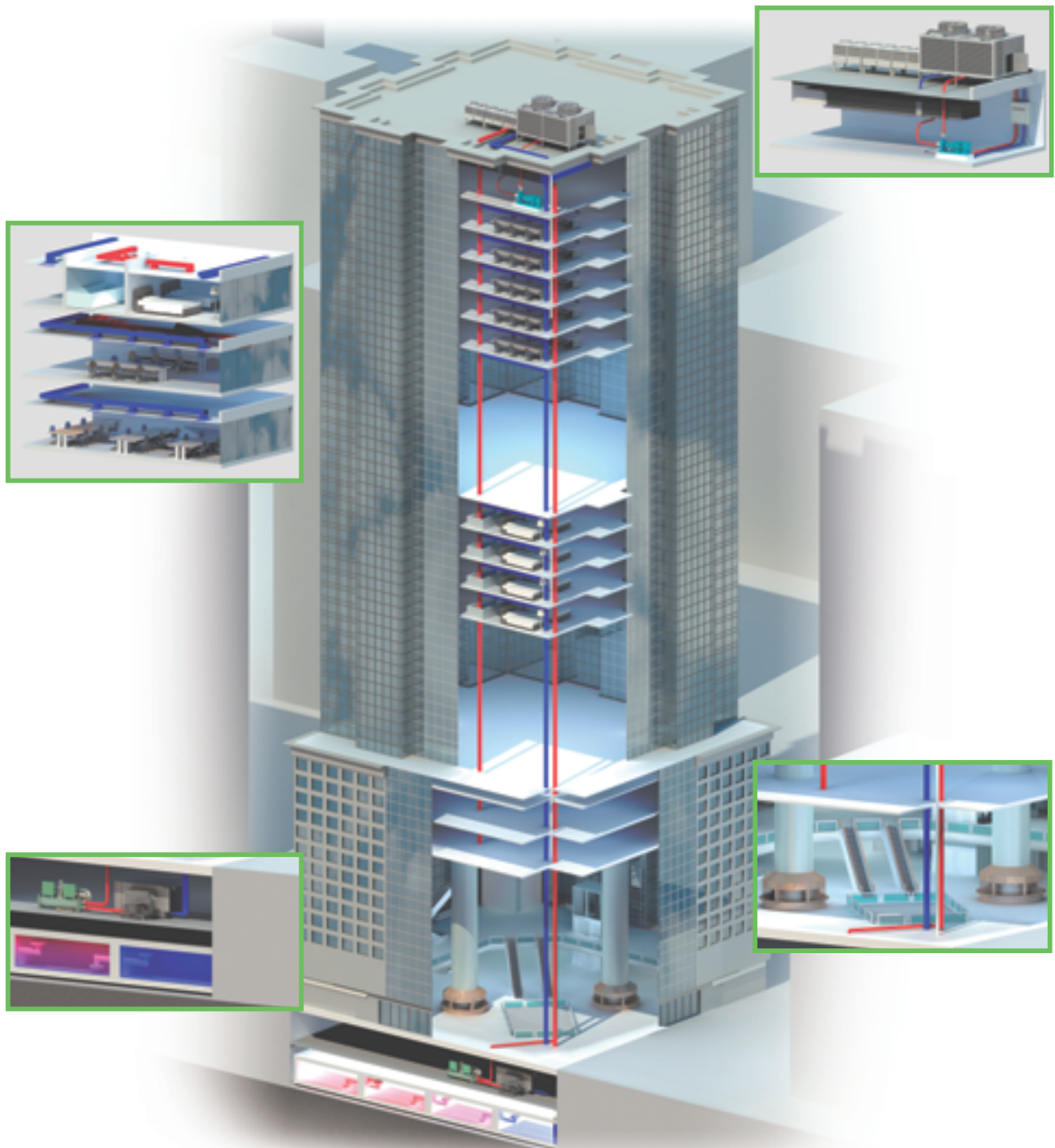

Optimum Control for HVAC Facilities

• Cooling Tower Fan

The cooling tower fan is used to cool the temperature of cooling water by emitting it into the air. The fan speed is adjusted optimally according to the cooling water temperature at the outlet. Moreover, the inverter estimates the wet-bulb temperature automatically to control the fan so that the temperature of cooling water (wet bulb) is interlocked to the air temperature. (Wet-bulb temperature presumption control)



• Cooling Water Pump

The cooling water pump circulates the cooling water to the cooling tower in order to cool the heat generated by the Refrigeration machine. The pump speed is adjusted optimally according to the temperature and flow rate of cooling water. Moreover, the inverter can control the cooling pump so that the difference of the cooling water temperature at between the inlet and outlet is constant. (Temperature difference constant control)
(*Use the Customized logic to the part of the control)



• Chilled Water Pump

The chilled water pump circulates the chilled water generated with the Refrigeration machine to the air conditioner and fan coil. The pump speed is adjusted optimally according to the header pressure. Moreover, the pump conveyance pressure can be controlled to the proper value by converting the flow rate signal to the target pressure using the linearization function. (Linearization function)
(*Use the Customized logic to the part of the control)



• Supply Fan / Return Fan

The speed of supply and return fans is adjusted optimally according to the pressure, discharge temperature, room temperature, and others. Moreover, the highest level of carbon dioxide is selected automatically by detecting the level in room to control it to stay within the allowable level.

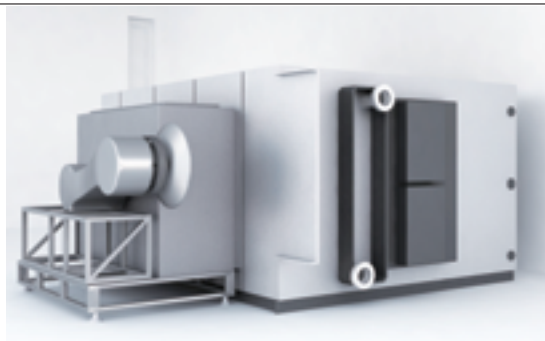

Optimal Structure Design

User Friendly, Easy to See Keypad

- The regulator is indicated by enlarging the LCD.

- | | | |
|----------------------------|-------------------|-----------------------|
| 1. Process Variable (PV) | 5. Output Current | 9. Power Consumption |
| 2. Set Value (SV) | 6. Output Voltage | 10. Cumulative Energy |
| 3. Manipulation Value (MV) | 7. Torque | |
| 4. Frequency | 8. Rotation Speed | |



*Possible to show understandable indications through the unit conversion function.
 *Multi-language function: 19 languages + user customized language supported

- Multi-language supported: 19 languages + user customized language

Language				
Japanese	English	Chinese	German	French
Spanish	Italian	Russian	Greek	Turkish
Malay	Vietnamese	Thai	Indonesian	Polish
Czech	Swedish	Portuguese	Dutch	

Real Time Clock (RTC) is Provided as Standard.

- Alarm information with date and time

- Alarm information for last ten times is stored and displayed with date and time.

Easy failure analysis

- Timer function

- Possible to set the maximum four timers for a week.
- Possible to set flag holidays (20 days a year).

Operation schedule can be set according to actual condition by using four timers.

Example

When operation is performed in the same schedule through a week

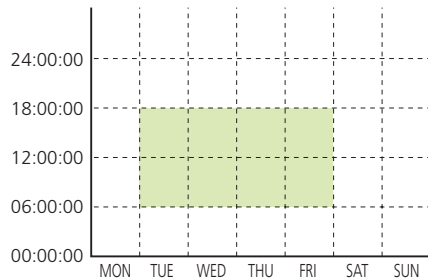

When operation schedule varies depending on the day of the week

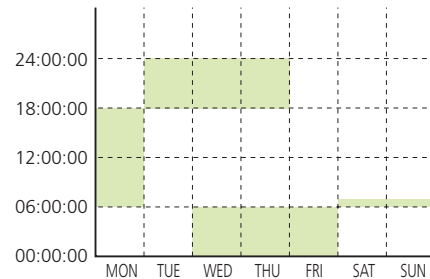

- Unit conversion function between PV and SV values

- Unit conversion allows you to easily set data.

Function	Units			
Unit conversion	No conversion	%	RPM	l/min
	m ³ /h	°C	mbar	bar
	kPa	mWG	mmHg	kW
	in-wg	psi	°F	ppm
	PSI			

1 User-Friendly, Easy to See Dedicated Keypad

Multi-language supported, HELP function featured, unit setting with SV and PV values, data copy (three kinds), detachable and can be attached on the panel (using an optional cable)

4 Capacitor Board

Outputs the life prediction signal determining capacitor capacity drop and cumulative running hours. This allows the user to grasp replacement period.

3 Control Terminal Block

The detachable control terminal block is adopted. This allows the unit to be replaced easily without disconnecting cables.

2 Control Board

USB port equipped, BACnet equipped as standard.
Max. three types of built-in optional boards can be mounted all together.
Optional battery connection
Various communications options

Standard equipment	Optional equipment
<ul style="list-style-type: none"> • BACnet MS/TP • Modbus RTU • Metasys N2 	<ul style="list-style-type: none"> • LonWorks • Ethernet • PROFIBUS-DP* • DeviceNet • CANopen • CC-Link

*Coming soon

5 Cooling Fan

Easy replacement just by simply removing and attaching the part. Prolonged life by controlling the fan ON and OFF.

6 EMC Filter

Drastically reduces noise. Provided to units of all capacities. Conforming to IEC61800-3.

7 DCR

Drastically reduces harmonic noise. Conforming to IEC/EN61000-3-2 and IEC/EN61000-3-12. Provided as standard to models up to 60HP (Three-phase 230V series), 125HP (Three-phase 460V series), 150HP (Three-phase 575V series), and can be attached externally as an option to models from 75 to 125HP (Three-phase 230V series), 150 to 1000HP (Three-phase 460V series), 200 to 300HP (Three-phase 575V series).

8 Environmental Immunity

3C2, IEC60721-3-3 supported

9 Others

Support/analysis software by loader, RTC backup by battery (option)

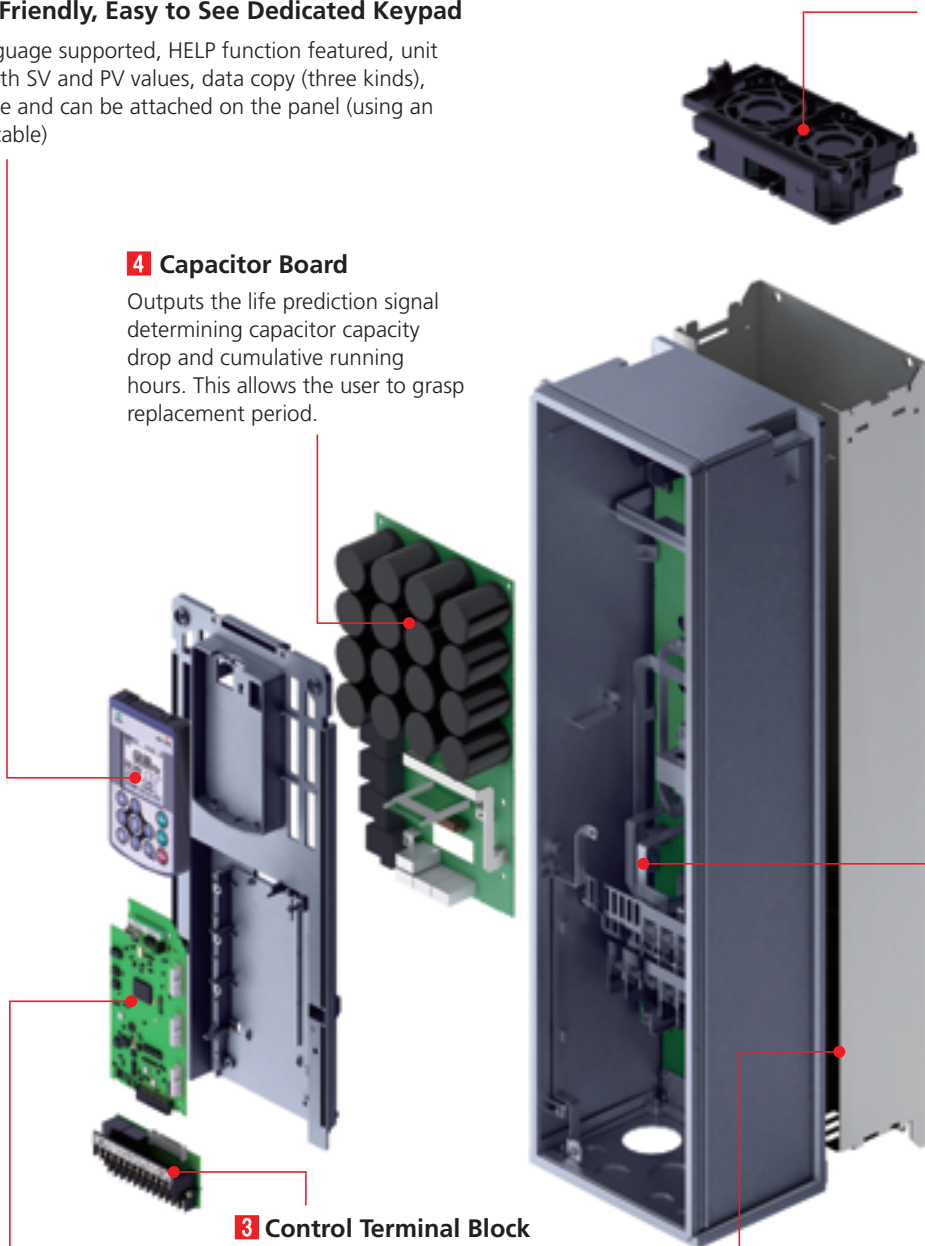

Functions Suitable for HVAC Use

Linearization Function

This function estimates the target pressure using the load flow rate, which allows the estimated terminal pressure to be controlled.

For an air-conditioning heat source system, the amount of the cooling or heating water fluctuates generally in seasons or days and nights. Therefore, operations continuing in a water conveyance pressure constant control may lead to high operating unnecessary pressures on terminals at low operating state. Thus, the pump consumes an ineffectual electric power for maintaining the high water conveyance pressure.

Based on the calculated value and water conveyance pressure of estimated terminal pressure using the detected load flow rate, PID control is performed.

It is possible to reduce the ineffectual pump power consumption and to achieve a great energy-saving effect together with maintaining comfortable current air conditioning.

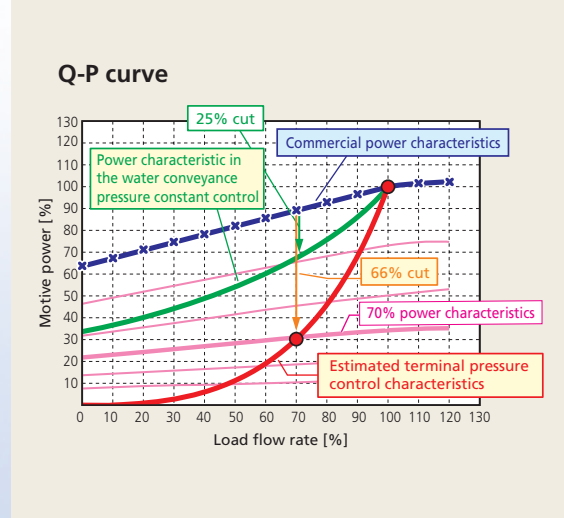
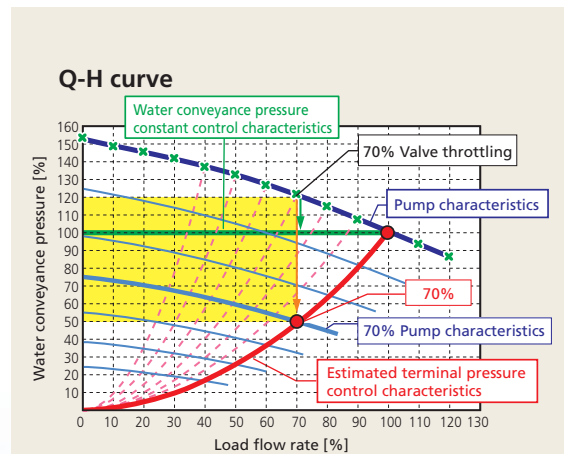
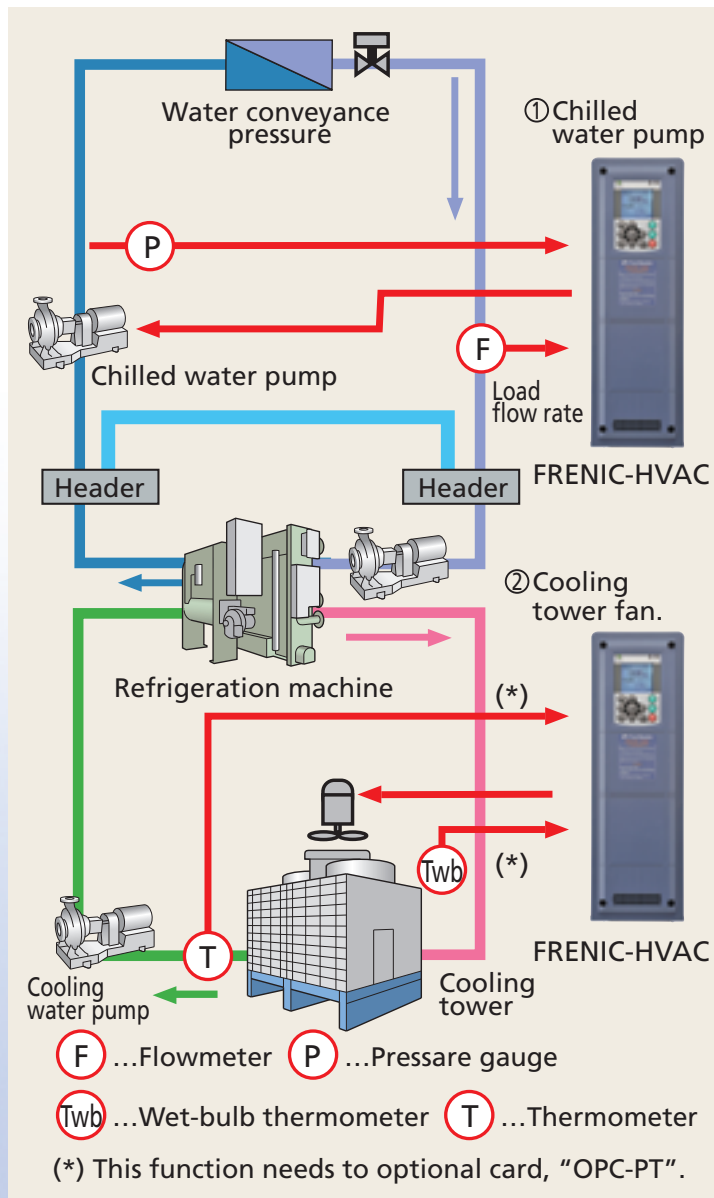

Wet-Bulb Temperature Presumption Control

This function is optimal for controlling the fan of cooling tower. Since the wet-bulb temperature would become higher than the set temperature when the air temperature is particularly high, water temperature will not reach the set temperature. Therefore, the fan keeps rotating at high speed, failing in energy-saving operation. FRENIC-HVAC automatically estimates the wet-bulb temperature and controls the fan so that the cooling water is interlocked with the air temperature in order not to use unnecessary electric power.

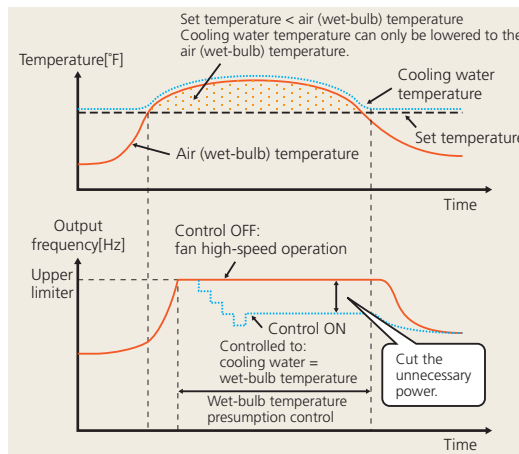

Filter Clogging Prevention Function

This function detects clogging of the fan filter with dust or other materials using the output current and pressure sensor value. When clogging is detected, the fan is rotated in reverse to eject dust, and then resumes rotation in forward to blow air. In addition, the function notifies you of maintenance necessity with the alarm signal.

Customized Logic

The customized logic interface function is provided to the inverter body. This enables forming of logic circuit and arithmetic circuit to the digital and analog input and output signals, allowing simple relay sequence to be built while processing the signals freely.

Example

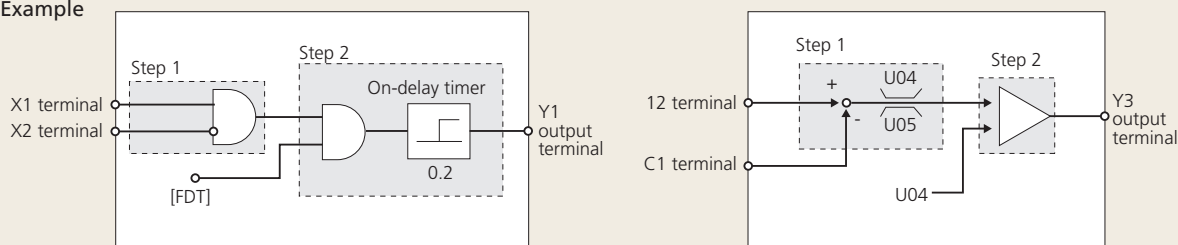

Standard 4 PID Control

The 4 PID control is featured as standard. One PID module is used to control the output frequency of the inverter, and the other three PIDs can be used to control the external system. To utilize all of four PIDs, the optional card (OPC-AIO) needs to be mounted.

Fire Mode (Forced Operation)

This mode ignores (retry) the inverter protection function to continue the operation. In that way, the inverter keeps operating the fan and pump as much as possible in case of emergency such as fire.

Password

Function codes can be read/write, displayed or hidden by setting the two passwords. This prevents erroneous operation or overwriting of function codes. In addition, if a wrong password was input exceeding the specified number of times, the inverter is restricted from operating as the user is regarded as improper.

Pick-up Operation Function

The pick-up operation function enables smooth starts. If you wish to run a fan currently not run by the inverter and in idle mode, this function searches the speed regardless of the direction of rotation and pick up the motion smoothly. This function allows for smooth operation such as when switching the power supply from the commercial power to inverter in a momentary action.

Standard Specifications

Three-phase 230 V Series (1 to 125 HP)

Item		Specifications																
Type *8	FRN □□□ AR1 ■ -2U : HVAC	001	002	003	005	007	010	015	020	025	030	040	050	060	075	100	125	
Nominal applied motor (Rated output) [HP] *1	Three phase input	AC208V motor	1	2	3	5	7.5	10	15	20	25	30	40	50	60	75	100	125
		AC230V motor	-	1/2	3/4	1.5	2	3	5	5	7.5	10	10	15	20	30	30	40
	Single phase input	AC208V motor	-	1/2	1	2	3	3	5	7.5	10	10	15	20	25	30	30	40
		AC230V motor	-	1/2	1	2	3	3	5	7.5	10	10	15	20	25	30	30	40
Output ratings	Three phase input	Rated capacity [kVA] *2	1.9	3.1	4.3	7.1	10	12	18	23	29	35	45	58	71	85	112	137
		Rated current [A]	5	8	11	18	27	31.8	46.2	59.4	74.8	88	115	146	180	215	283	346
	Single phase input	Rated capacity [kVA] *2	0.7	1.2	1.6	2.7	4.1	4.9	7.1	9.2	11	13	17	22	27	37	40	52
		Rated current [A]	1.9	3.1	4.2	7	10.5	12.4	18	23.1	29.1	34.3	44.8	56.9	70.2	95	102	131
	Rated voltage [V] *3		Three-phase, 200 to 240 V (with AVR function)									Three-phase, 200 to 230 V (with AVR function)						
	Overload capability		110% - 1 min (Overload capability interval : IEC 61800-2 compliant)															
Rated frequency [Hz]		50, 60Hz																
Input ratings	Three phase input	Main circuit power input : Phases, voltage, frequency	Three-phase, 200 to 240 V, 50/60 Hz									Three-phase, 200 to 220 V, 50 Hz, Three-phase, 200 to 230 V, 60 Hz						
		Rated current [A] *6	2.8	5.3	7.5	12.9	18.0	24.2	36.0	48.6	60.0	71.5	96.9	121	145	177	246	291
	Required power supply capacity [kVA]		1.2	2.2	3.0	5.2	7.2	10	15	20	24	29	39	49	58	71	98	116
	Single phase input	Main circuit power input : Phases, voltage, frequency	Single-phase, 200 to 240 V, 50/60 Hz									Single-phase, 200 to 220 V, 50 Hz, Single-phase, 200 to 230 V, 60 Hz						
		Rated current [A] *6	2.8	5.3	7.5	12.9	18.0	24.2	36.0	48.6	60.0	71.5	96.9	121	145	177	246	291
	Required power supply capacity [kVA]		0.7	1.3	1.8	3.0	4.2	5.6	8.3	12	14	17	23	28	34	41	57	67
	Auxiliary control power input : Phases, voltage, frequency		Single-phase 200 to 240 V, 50/60 Hz									Single-phase 200 to 230 V, 50/60 Hz						
Auxiliary power input for main circuit : Phases, voltage, frequency *4		-									Single-phase 200 to 220 V, 50 Hz, Single-phase 200 to 230 V, 60 Hz							
Voltage, frequency variations		Voltage: +10 to -15% (Interphase voltage unbalance : 2% or less) *5, Frequency: +5 to -5%																
Braking	Torque [%] *7	20									10 to 15							
	DC injection braking	Starting frequency:0.0 to 60.0Hz, Braking time:0.0 to 30.0s, Braking level:0 to 60%																
EMC filter (IEC/EN 61800-3:2004) *10		EMC standards compliance : Category C2 (emission) / 2nd Env. (Immunity)														C3/ 2nd.		
DC reactor (DCR) *10		Built-in (IEC/EN 61000-3-2 *9, IEC/EN 61000-3-12)														Standard accessory (IEC/EN 61000-3-12)		
Power factor (at rated load)	Displacement P.F. (cosφ)	>0.98																
	True P.F.	≥0.90																
Efficiency (at rated load)		97%									98%							
Applicable (safety) standards		UL508C, C22.2 No.14, IEC/EN 61800-5-1:2007, SEMI F47-0706																
Enclosure	IEC/EN 60529	IP21/ IP55									IP00							
	NEMA/UL 50	NEMA/UL TYPE 1, NEMA/ UL TYPE 12									UL open type							
Cooling method		Fan cooling																
Weight/Mass [kg(lbs)]	IP21/UL TYPE1	10(22)	10(22)	10(22)	10(22)	18(40)	18(40)	18(40)	23(51)	23(51)	50(110)	50(110)	70(154)	70(154)				
	IP55/UL TYPE12	10(22)	10(22)	10(22)	10(22)	18(40)	18(40)	18(40)	23(51)	23(51)	50(110)	50(110)	70(154)	70(154)				
	IP00/Open															42(93)	43(95)	62(137)

*1) US 4-pole standard induction motor.

*2) Rated capacity is calculated by assuming the output rated voltage as 230 V.

*3) Output voltage cannot exceed the power supply voltage. At single-phase input use, the output voltage may be lower than three-phase input.

*4) The auxiliary power input is used as an AC power input when combining the unit to DC power supply such as high power factor PWM converter with power regenerative function. (Generally not to be used.)

*5) Voltage unbalance [%] = (Max. voltage [V] - Min. voltage [V])/Three-phase average voltage [V] x 67 (See IEC61800-3.)
If this value is 2 to 3%, use an optional AC reactor (ACR).

*6) The value is calculated on assumption that the inverter is connected with a power supply 230V, 50Hz and Rsc=120.

*7) Average braking torque for the motor running alone. (It varies with the efficiency of the motor.)

*8) The box (□) replaces a numeric letter depending on the drive capacity.

The box (■) replaces an alphabetic letter depending on the enclosure. M (IP21/UL TYPE1), L (IP55/UL TYPE12) or S (IP00/Open)

*9) It is applicable when the power supply is supplied from 3-phase 200V series transformer which is through 3-phase 400V series transformer.

*10) EMC filters and DCR does not conform to each corresponding standards when single phase input use.

Three-phase 460 V Series (1 to 75 HP)

Item		Specifications														
Type *8	FRN □□□ AR1 ■ -4U : HVAC	001	002	003	005	007	010	015	020	025	030	040	050	060	075	
Nominal applied motor (Rated output) [HP] *1	Three phase input	1	2	3	5	7.5	10	15	20	25	30	40	50	60	75	
	Single phase input	-	1/2	1	2	3	3	5	7.5	10	10	15	20	25	30	
Output ratings	Three phase input	Rated capacity [kVA] *2	1.9	3.2	4.3	7.1	10	14	19	25	31	35	47	59	72	89
		Rated current [A]	2.5	4.1	5.5	9.0	13.5	18.5	24.5	32	39	45	60	75	91	112
		Rated capacity [kVA] *2	-	1.1	1.6	2.7	4.1	5.7	7.5	9.8	12	13	18	23	28	34
	Single phase input	Rated current [A]	-	1.5	2.1	3.5	5.2	7.2	9.5	12.4	15.2	17.5	23.4	29.2	35.4	43.6
		Rated voltage [V] *3	Three-phase, 380 to 480 V (with AVR function)													
	Overload capability	110% - 1 min (Overload capability interval : IEC 61800-2 compliant)														
Rated frequency [Hz]	50, 60Hz															
Input ratings	Three phase input	Main circuit power input : Phases, voltage, frequency	Three-phase, 380 to 480 V, 50/60 Hz												Three-phase, 380 to 440 V, 50 Hz Three-phase, 380 to 480 V, 60 Hz	
		Rated current [A] *6	1.4	2.7	3.8	6.5	9.0	12.1	18.0	24.3	30.0	35.8	48.5	60.4	72.3	88.7
		Required power supply capacity [kVA]	1.2	2.2	3.1	5.2	7.2	10	15	20	24	29	39	49	58	71
	Single phase input	Main circuit power input : Phases, voltage, frequency	Single-phase, 380 to 480 V, 50/60 Hz												Single-phase, 380 to 440 V, 50 Hz Single-phase, 380 to 480 V, 60 Hz	
		Rated current [A] *6	-	2.7	3.8	6.5	9.0	12.1	18.0	24.3	30.0	35.8	48.5	60.4	72.3	88.7
	Required power supply capacity [kVA]	-	1.3	1.8	3.0	4.2	5.6	8.3	12	14	17	23	28	34	41	
Auxiliary control power input : Phases, voltage, frequency	Single-phase, 380 to 480 V, 50/60 Hz															
Auxiliary power input for main circuit: Phases, voltage, frequency *4	-															
Voltage, frequency variations	Voltage: +10 to -15% (Interphase voltage unbalance : 2% or less) *5, Frequency: +5 to -5%															
Braking	Torque [%] *7	20												10 to 15		
	DC injection braking	Starting frequency:0.0 to 60.0Hz, Braking time:0.0 to 30.0s, Braking level:0 to 60%														
EMC filter (IEC/EN 61800-3:2004) *9	EMC standards compliance : Category C2 (emission) / 2nd Env. (Immunity)															
DC reactor (DCR) *9	Built-in (IEC/EN 61000-3-2, IEC/EN 61000-3-12)															
Power factor (at rated load)	Displacement P.F. (cosφ)	> 0.98														
	True P.F.	≥ 0.90														
Efficiency (at rated load)	95%		96%		97%				98%							
Applicable (safety) standards	UL508C, C22.2 No.14, IEC/EN 61800-5-1:2007, SEMI F47-0706															
Enclosure	IEC/EN 60529	IP21/ IP55														
	NEMA/UL 50	NEMA/UL TYPE 1, NEMA/UL TYPE 12														
Cooling method	Fan cooling															
Weight/Mass [kg(lbs)]	IP21/UL TYPE1	10(22)	10(22)	10(22)	10(22)	10(22)	10(22)	18(40)	18(40)	18(40)	18(40)	23(51)	23(51)	50(110)	50(110)	
	IP55/UL TYPE12	10(22)	10(22)	10(22)	10(22)	10(22)	10(22)	18(40)	18(40)	18(40)	18(40)	23(51)	23(51)	50(110)	50(110)	

Three-phase 460 V Series (100 to 1000 HP)

Item		Specifications														
Type *8	FRN □□□ AR1 ■ -4U : HVAC	100	125	150	200	250	300	350	450	500	600	800	900	1000		
Nominal applied motor (Rated output) [HP] *1	Three phase input	100	125	150	200	250	300	350	450	500	600	800	900	1000		
	Single phase input	40	50	60	75	75	100	125	150	200	200	300	300	350	450	
Output ratings	Three phase input	Rated capacity [kVA] *2	119	140	167	201	242	300	330	414	517	589	764	932	1091	
		Rated current [A]	150	176	210	253	304	377	415	520	650	740	960	1170	1370	
		Rated capacity [kVA] *2	46	54	65	78	94	117	128	160	201	229	297	363	425	
	Single phase input	Rated current [A]	58.5	68.6	81.9	98.6	118	147	161	202	253	288	374	456	534	
		Rated voltage [V] *3	Three-phase, 380 to 480 V (with AVR function)													
	Overload capability	110% - 1 min (Overload capability interval : IEC 61800-2 compliant)														
Rated frequency [Hz]	50, 60Hz															
Input ratings	Three phase input	Main circuit power input : Phases, voltage, frequency	Three-phase, 380 to 440 V, 50 Hz							Three-phase, 380 to 480 V, 60 Hz						
		Rated current [A] *6	119	141	175	207	249	311	340	435	547	614	767	970	1093	
		Required power supply capacity [kVA]	95	113	140	165	199	248	271	347	436	490	612	773	871	
	Single phase input	Main circuit power input : Phases, voltage, frequency	Single-phase, 380 to 440 V, 50 Hz							Single-phase, 380 to 480 V, 60 Hz						
		Rated current [A] *6	119	141	175	207	249	311	340	435	547	614	767	970	1093	
	Required power supply capacity [kVA]	55	65	81	96	115	144	157	201	252	283	353	447	503		
Auxiliary control power input : Phases, voltage, frequency	Single-phase, 380 to 480 V, 50/60 Hz															
Auxiliary power input for main circuit: Phases, voltage, frequency *4	Single-phase, 380 to 440 V, 50 Hz							Single-phase, 380 to 480 V, 60 Hz								
Voltage, frequency variations	Voltage: +10 to -15% (Interphase voltage unbalance : 2% or less) *5, Frequency: +5 to -5%															
Braking	Torque [%] *7	10 to 15														
	DC injection braking	Starting frequency:0.0 to 60.0Hz, Braking time:0.0 to 30.0s, Braking level:0 to 60%														
EMC filter (IEC/EN 61800-3:2004) *9	C2/ 2nd.		EMC standards compliance : Category C3 (emission) / 2nd Env. (Immunity)													
DC reactor (DCR) *9	Built-in (IEC/EN 61000-3-2, IEC/EN 61000-3-12)		Standard accessory (IEC/EN 61000-3-12)													
Power factor (at rated load)	Displacement P.F. (cosφ)	> 0.98														
	True P.F.	≥ 0.90														
Efficiency (at rated load)	98%															
Applicable (safety) standards	UL508C, C22.2 No.14, IEC/EN 61800-5-1:2007, SEMI F47-0706															
Enclosure	IEC/EN 60529	IP21/ IP55		IP00												
	NEMA/UL 50	NEMA/UL TYPE 1, NEMA/UL TYPE 12		UL open type												
Cooling method	Fan cooling															
Weight/Mass [kg(lbs)]	IP21/UL TYPE1	70(154)	70(154)													
	IP55/UL TYPE12	70(154)	70(154)													
	IP00/Open	-	-	62(137)	64(141)	94(207)	98(216)	129(284)	140(309)	245(540)	245(540)	330(728)	530(1168)	530(1168)		

*1) US 4-pole standard induction motor.

*2) Rated capacity is calculated by assuming the output rated voltage as 460 V.

*3) Output voltage cannot exceed the power supply voltage. At single-phase input use, the output voltage may be lower than three-phase input.

*4) The auxiliary power input is used as an AC power input when combining the unit to DC power supply such as high power factor PWM converter with power regenerative function. (Generally not to be used.)

*5) Voltage unbalance [%] = (Max. voltage [V] - Min. voltage [V])/Three-phase average voltage [V] x 100 (See IEC61800-3.) If this value is 2 to 3%, use an optional AC reactor (ACR).

*6) The value is calculated on assumption that the inverter is connected with a power supply 460V, 50Hz and Rsc=120.

*7) Average braking torque for the motor running alone. (It varies with the efficiency of the motor.)

*8) The box (□) replaces a numeric letter depending on the drive capacity. The box (■) replaces an alphabetic letter depending on the enclosure. M (IP21/UL TYPE1), L (IP55/UL TYPE12) or S (IP00/Open)

*9) EMC filters and DCR does not conform to each corresponding standards when single phase input use.

Standard Specifications

Three-phase 575 V Series (1 to 30 HP)

Item		Specifications											
Type ^{*8}	FRN <input type="checkbox"/> <input type="checkbox"/> <input type="checkbox"/> <input type="checkbox"/> AR1 <input checked="" type="checkbox"/> -5U : HVAC	001	002	003	005	007	010	015	020	025	030		
Nominal applied motor (Rated output) [HP] ^{*1}	Three phase input	1	2	3	5	7.5	10	15	20	25	30		
	Single phase input	-	1/2	3/4	1.5	2	3	5	5	7.5	10		
Output ratings	Three phase input	Rated capacity [kVA] ^{*2}	1.6	2.7	3.8	6.1	9.2	11	16	21	26	31	
		Rated current [A]	1.7	2.8	3.9	6.2	9.3	12	17	22	27	32	
		Rated capacity [kVA] ^{*2}	-	0.9	1.4	2.3	3.5	4.5	6.5	8.4	10	12	
	Single phase input	Rated current [A]	-	1.0	1.5	2.4	3.6	4.6	6.6	8.5	10.5	12.4	
		Rated voltage [V] ^{*3}	Three-phase, 575 to 600 V (with AVR function)										
		Overload capability	110% - 1 min (Overload capability interval: IEC 61800-2 compliant)										
Rated frequency [Hz]	50, 60Hz												
Input ratings	Three phase input	Main circuit power input : Phases, voltage, frequency	Three-phase, 575 to 600 V, 50/60 Hz										
		Rated current [A] ^{*6}	1.2	2.1	3.0	5.2	7.2	9.7	14.4	19.5	24.0	28.6	
		Required power supply capacity [kVA]	1.2	2.1	3.0	5.2	7.2	10	15	20	24	29	
	Single phase input	Main circuit power input : Phases, voltage, frequency	Single-phase, 575 to 600 V, 50/60 Hz										
		Rated current [A] ^{*6}	-	2.1	3.0	5.2	7.2	9.7	14.4	19.5	24.0	28.6	
		Required power supply capacity [kVA]	-	1.3	1.8	3.0	4.2	5.6	8.3	12	14	17	
Auxiliary control power input : Phases, voltage, frequency	Single-phase 575 to 600 V, 50/60 Hz												
Auxiliary power input for main circuit : Phases, voltage, frequency ^{*4}	-												
Voltage, frequency variations	Voltage: +10 to -15% (Interphase voltage unbalance: 2% or less) ^{*5} , Frequency: +5 to -5%												
Braking	Torque [%] ^{*7}	20											
	DC injection braking	Starting frequency: 0.0 to 60.0Hz, Braking time: 0.0 to 30.0s, Braking level: 0 to 60%											
EMC filter (IEC/EN 61800-3:2004) ^{*9}	EMC standards compliance: Category C3 (emission)/ 2nd Env. (Immunity)												
DC reactor (DCR) ^{*9}	Built-in (IEC/EN 61000-3-2, IEC/EN 61000-3-12)												
Power factor (at rated load)	Displacement P.F. (cosφ)	>0.98											
	True P.F.	≥0.90											
Efficiency (at rated load)	95%		96%		97%				98%				
Applicable (safety) standards	UL508C, C22.2 No.14, IEC/EN 61800-5-1:2007												
Enclosure	IEC/EN 60529	IP21/ IP55											
	NEMA/UL 50	NEMA/UL TYPE 1, NEMA/ UL TYPE 12											
Cooling method	Fan cooling												
Weight/Mass [kg(lbs)]	IP21/UL TYPE1	10(22)	10(22)	10(22)	10(22)	10(22)	10(22)	18(40)	18(40)	18(40)	18(40)		
	IP55/UL TYPE12	10(22)	10(22)	10(22)	10(22)	10(22)	10(22)	18(40)	18(40)	18(40)	18(40)		

Three-phase 575 V Series (40 to 300 HP)

Item		Specifications											
Type ^{*8}	FRN <input type="checkbox"/> <input type="checkbox"/> <input type="checkbox"/> <input type="checkbox"/> AR1 <input checked="" type="checkbox"/> -5U : HVAC	040	050	060	075	100	125	150	200	250	300		
Nominal applied motor (Rated output) [HP] ^{*1}	Three phase input	40	50	60	75	100	125	150	200	250	300		
	Single phase input	10	15	20	25	30	40	50	75	100	100		
Output ratings	Three phase input	Rated capacity [kVA] ^{*2}	40	51	62	76	103	124	145	210	260	287	
		Rated current [A]	41	52	63	77	104	125	146	211	262	289	
		Rated capacity [kVA] ^{*2}	15	20	24	29	40	48	56	81	101	111	
	Single phase input	Rated current [A]	15.9	20.2	24.5	30.0	40.5	48.7	56.9	82.2	102	112	
		Rated voltage [V] ^{*3}	Three-phase, 575 to 600 V (with AVR function)										
		Overload capability	110% - 1 min (Overload capability interval: IEC 61800-2 compliant)										
Rated frequency [Hz]	50, 60Hz												
Input ratings	Three phase input	Main circuit power input : Phases, voltage, frequency	Three-phase, 575 to 600 V, 50/60 Hz										
		Rated current [A] ^{*6}	38.8	48.3	57.9	71.0	94.7	113	140	199	249	272	
		Required power supply capacity [kVA]	39	49	58	71	95	113	140	199	248	271	
	Single phase input	Main circuit power input : Phases, voltage, frequency	Single-phase, 575 to 600 V, 50/60 Hz										
		Rated current [A] ^{*6}	38.8	48.3	57.9	71.0	94.7	113	140	199	249	272	
		Required power supply capacity [kVA]	23	28	34	41	55	65	81	115	144	157	
Auxiliary control power input : Phases, voltage, frequency	Single-phase 575 to 600 V, 50/60 Hz												
Auxiliary power input for main circuit : Phases, voltage, frequency ^{*4}	-												
Voltage, frequency variations	Voltage: +10 to -15% (Interphase voltage unbalance: 2% or less) ^{*5} , Frequency: +5 to -5%												
Braking	Torque [%] ^{*7}	10 to 15											
	DC injection braking	Starting frequency: 0.0 to 60.0Hz, Braking time: 0.0 to 30.0s, Braking level: 0 to 60%											
EMC filter (IEC/EN 61800-3:2004) ^{*9}	EMC standards compliance: Category C3 (emission)/ 2nd Env. (Immunity)												
DC reactor (DCR) ^{*9}	Built-in (IEC/EN 61000-3-2, IEC/EN 61000-3-12) Standard accessory (IEC/EN 61000-3-12)												
Power factor (at rated load)	Displacement P.F. (cosφ)	>0.98											
	True P.F.	≥0.90											
Efficiency (at rated load)	98%												
Applicable (safety) standards	UL508C, C22.2 No.14, IEC/EN 61800-5-1:2007												
Enclosure	IEC/EN 60529	IP21/ IP55								IP00			
	NEMA/UL 50	NEMA/UL TYPE 1, NEMA/ UL TYPE 12								UL open type			
Cooling method	Fancooling												
Weight/Mass [kg(lbs)]	IP21/UL TYPE 1	23(51)	23(51)	50(110)	50(110)	70(154)	70(154)	70(154)	-				
	IP55/UL TYPE 12	23(51)	23(51)	50(110)	50(110)	70(154)	70(154)	70(154)	-				
	IP00/Open	-								94(207)	98(216)	98(216)	

*1) US 4-pole standard induction motor.

*2) Rated capacity is calculated by assuming the output rated voltage as 575 V.

*3) Output voltage cannot exceed the power supply voltage. At single-phase input use, the output voltage may be lower than three-phase input.

*4) The auxiliary power input is used as an AC power input when combining the unit to DC power supply such as high power factor PWM converter with power regenerative function. (Generally not to be used.)

*5) Voltage unbalance [%] = (Max. voltage [V] - Min. voltage [V])/Three-phase average voltage [V] x 67 (See IEC 61800-3.) If this value is 2 to 3%, use an optional AC reactor (ACR).

*6) The value is calculated on assumption that the inverter is connected with a power supply 575V, 50Hz and Rsc=120.

*7) Average braking torque for the motor running alone. (It varies with the efficiency of the motor.)

*8) The underline () replaces an numeric letter depending on the drive capacity. The box () replaces an alphabetic letter depending on the enclosure. M (IP21), L (IP55) or S (IP00)



*9) EMC filters and DCR does not conform to each corresponding standards when single phase input use.

Common Specifications

Items		Specifications	Remarks	
Output	Maximum frequency	• 25 to 120 Hz		
	Base frequency	• 25 to 120 Hz variable setting		
	Starting frequency	• 0.1 to 60.0 Hz variable setting		
	Carrier frequency	Three-phase 230V series • 0.75 to 16 kHz variable setting (1HP to 25HP) • 0.75 to 10 kHz variable setting (30HP to 100HP) • 0.75 to 6 kHz variable setting (125HP) Three-phase 460V series • 0.75 to 16 kHz variable setting (1HP to 50HP) • 0.75 to 10 kHz variable setting (60HP to 125HP) • 0.75 to 6 kHz variable setting (150HP to 900HP) • 0.75 to 4 kHz variable setting (1000HP)	575V series: • 0.75 to 16 kHz variable setting (1 HP to 50 HP) • 0.75 to 10 kHz variable setting (60 HP to 125 HP) • 0.75 to 6 kHz variable setting (150 HP to 300 HP)	
	Output frequency Accuracy (Stability)	• Analog setting : $\pm 0.2\%$ of max. frequency (at 25°C(77°F) $\pm 10^\circ\text{C}$ (50°F)) • Digital setting : $\pm 0.01\%$ of max. frequency (at -10°C(14°F) to +50°C(122°F))		
	Setting resolution	• Analog setting : 1/3000 of max. frequency (1/1500 with [V2] input) • Digital setting : 0.01 Hz (99.99 Hz or less), 0.1Hz (100.0 to 120 Hz) • Link setting : 1/20000 of max. frequency or 0.01 Hz (fixed)		
Control	Control method	• V/f control • Dynamic torque vector control • V/f control with slip compensation.		
	Voltage/frequency characteristic	230V series	• Base frequency and max. output frequency can be set to 80 to 240V in common. • The AVR control ON/OFF can be selected. • Non-linear V/f setting (2 points) : Free voltage (0 to 240 V) and frequency (0 to 120 Hz) can be set.	
		460V series	• Base frequency and max. output frequency can be set to 160 to 500V in common. • The AVR control ON/OFF can be selected. • Non-linear V/f setting (2 points) : Free voltage (0 to 500 V) and frequency (0 to 120 Hz) can be set.	
		575V series	• Base frequency and max. output frequency can be set to 200 to 600 V in common. • The AVR control ON/ OFF can be selected. • Non-linear V/f setting (2 points): Free voltage (0 to 600 V) and frequency (0 to 120 Hz) can be set.	
	Torque boost	• Auto torque boost • Manual torque boost : Desired torque boost (0.0 to 20.0%) can be set. • Select application load with function code.(Constant torque load or variable torque load)		
	Starting torque	• 100% or higher/set frequency : 1.0 Hz • Base frequency 50 Hz, Slip compensation and auto torque boost operation		
	Start/stop operation	• Keypad : Start and stop with FWD , REV and STOP keys. • External signals (digital inputs) : Forward (Reverse) rotation, stop command (capable of 3-wire operation), coast-to-stop command, external alarm, alarm reset, etc. • Link operation : Operation through RS-485 or field bus (option) communications. • Switching operation command : Remote/Local switching, link switching.		
	Frequency setting	• Keypad : Can be set with and keys. • External Volume : Can be Set with external potentiometer (1 to 5kΩ 1/2W). • Analog input : 0 to ± 10 VDC (± 5 VDC)/0 to $\pm 100\%$ (Terminals [12] and [V2]) 0 to +10 VDC (+5 VDC)/0 to +100% (Terminals [12] and [V2]) +4 to +20 mADC/0 to 100% (Terminal [C1]) 0 to +20 mADC/0 to 100% (Terminal [C1]) • UP/DOWN operation : Frequency can be increased or decreased while the digital input signal is ON. • Multi-frequency : Selectable from 16 steps (step 0 to 15). • Link operation : Frequency can be set via RS-485 (Standard accessory). • Switching frequency setting : Frequency setting can be switched (2 settings) by external signal (digital input). Remote/local switching, link switching. • Auxiliary frequency setting : Terminal [12],[C1] or [V2] input can be selected respectively as an additional input. • Inverse operation : The setting "0 to +10 VDC/0 to 100%" can be switched to "+10 to 0 VDC/0 to 100%" by external command. The setting "+4 to +20 mADC/0 to 100%" can be switched to "+20 to +4 mADC/0 to 100%" by external command. The setting "0 to +20 mADC/0 to 100%" can be switched to "+20 to 0 mADC/0 to 100%" by external command. • Programmed PATTERN operation : Maximum 7 steps can be set.	"+1 to +5 VDC" can be adjusted with bias and analog input gain.	
	Acceleration/ deceleration time	• Setting range : 0.00 to 3600 s • Switch : Four types of accel./decel. time can be set or selected individually. (switchable during operation) • Acceleration/deceleration pattern : Linear accel./decel., S-shape accel./decel. (weak, strong), curvilinear accel./decel. (accel./decel. max. capacity of constant output) • Deceleration mode (coast-to-stop) : Coast-to-stop at the operation command OFF. • Forcible stop decel. time : Deceleration stop by the forcible stop .		
	Frequency limiter (Upper limit and lower limit frequencies)	• Both upper and lower limit frequencies can be set in Hertz. • It is possible to choose the operation done from continuous operation at lower limit frequency or operation stop when the set frequency drops below the lower limit.		
	Bias frequency	• Bias of set reference frequency and PID command can be independently set. (setting range : 0 to $\pm 100\%$)		
	Analog input	• Gain : Setting in the range from 0 to 200%. • Offset : Setting in the range from -5.0 to +5.0%. • Filter : Setting in the range from 0.00s to 5.00s.		
	Jump frequency	• Actuation (frequency) points (3 points) and their common jump widths (0 to 30 Hz) can be set. • Resonance points can be detected automatically and used to set the jump frequency automatically.		
	Auto-restart after momentary power failure	• Trip at power failure : The inverter trips immediately after power failure. • Trip at power recovery : Coast-to-stop at power failure and trip at power recovery. • Continuous operation : Operation is continued using the load (inertia) energy. • Start at the frequency selected before momentary stop : Coast-to-stop at power failure and start after power recovery at the frequency selected before momentary stop. • Start at starting frequency : Coast-to-stop at power failure and start at the starting frequency after power recovery.		
Current limit by hardware	• Limiting the current by hardware to prevent overcurrent trip due to sharp load change or momentary power failure which cannot be controlled by software current limit. (This function can be cancelled.)			
Operation by commercial power supply	• With commercial power switching command, the inverter outputs 50Hz/60 Hz (SW50, SW60). • The inverter has the commercial power supply switching sequence.			

Common Specifications

	Items	Specifications	Remarks
Control	Slip compensation	• Compensates for decrease in speed according to the load.	
	Torque limiter	• Switchable between 1st or 2nd torque limit values.	
	Current control (software current limit)	• Automatically reduces the frequency so that the output current becomes lower than the preset operation level.	
	PID control	• PID adjuster for process control • Switchable between forward and reverse operations • Slow flowrate stop function (pressurized operation available before slow flowrate) • Automatic update for slow flowrate frequency • PID command : Keypad panel, analog input (from terminals [12],[C1],[V2]), RS-485 communications • PID feedback value : Analog input (from terminals [12],[C1],[V2]) • Alarm output (absolute value alarm, deviation alarm) • PV level detection • Scaling for PV value • PV value conversion/calculation of analog input • PID output limiter • Integration reset/hold • Antireset windup • PID auto tuning	
	Auto search for idling motor speed	• Estimates the speed of the motor running under no load and starts to control the motor without stopping it. (Motor electric constant needs tuning : Offline tuning)	
	Automatic deceleration	• If the DC link voltage or calculated torque exceeds the automatic deceleration level during deceleration, the inverter automatically prolongs the deceleration time to avoid overvoltage trip. (It is possible to select forcible deceleration actuated with more than three times longer deceleration.) • If the calculated torque exceeds automatic deceleration level during constant speed operation, the inverter avoids overvoltage trip by increasing the frequency. • Automatic deceleration level can be set.	
	Deceleration characteristic (improving braking ability)	• The motor loss is increased during deceleration to reduce the regenerative energy in the inverter in order to avoid overvoltage trip.	
	Automatic energy saving operation	• The output voltage is controlled to minimize the total sum of the motor loss and inverter loss at a constant speed.	
	Overload prevention control	• If the ambient temperature or IGBT junction joint temperature increases due to overload, the inverter lowers the output frequency to avoid overload.	
	Voltage Shortage/Avoidance Operation	• The continuous operation is available reducing output frequency during low voltage.	
	Input Phase Loss Protection Avoidance Operation	• Selectable from trip or continuous low power operation.	
	Off-line tuning	• Dynamic and static type are available for tuning the motor constants.	
	Cooling fan ON/OFF control	• Detects inverter internal temperature of the inverter and stops the cooling fan when the temperature is low. • The fan control signal can be output to an external device.	
	Universal DI	• The status of external digital signal connected with the universal digital input terminal is transferred to the host controller.	
	Universal DO	• Digital command signal from the host controller is output to the universal digital output terminal.	
	Universal AO	• The analog command signal from the host controller is output to the analog output terminal.	
	Rotation direction control	• Preventing reverse rotation • Preventing forward rotation	
	Preventing condensation in motor	• When the inverter is stopped, current is automatically supplied to the motor to keep the motor warm and avoid condensation.	
	Customized logic interface	• Available in 14 steps using functions of 2-input, 1-output, logical calculation, and timer function.	
	Pump control	• Periodic motor switching • Promptly connection/disconnection for auxiliary motor • Filter clogging prevention • Anti jam • Wet-bulb temperature presumption control	
	Fire mode	• Continues operation without alarm by retry.	
	Pattern operation	• Pattern operation is available by inverter function.	
	Real time clock (RTC)	• Date, hour and alarm information with date and hour can be displayed, and timer operation can be used with RTC. • Daylight saving time auxiliary function.	Time can be maintained with battery (option).
Timer operation	• Set 4-timers for one week.		
Password function	• Prevent improper operation and/or data being displayed (two level setting).		
External PID control	• PID processor for process control / On / Off controller (3 channels) • Normal operation / inverse operation • PID command: Keypad, analog input (terminals [12], [C1] and [V2]), RS-485 • PID feedback value (terminals [12], [C1] and [V2]) • Alarm output (absolute value alarm, deviation alarm) • PID feedback error detection • Sensor input amount scaling • Sensor input amount conversion / calculation • PID output limiter • Integration reset / hold • Anti-reset wind-up function		
Display	Run/stop	Speed monitor (set frequency, output frequency, motor speed, load shaft speed, line speed, and speed indication with percent), Output current [A], output voltage [V], calculated torque [%], input power [kW], PID reference value, PID feedback value, PID output, load [%], motor output [kW], analog input monitor, energy consumption [kWh]/[MWh] effective current value for each phase [A]	
	Inverter life warning	• Life judgment of the main circuit capacitor, electrolytic capacitor on printed circuit board, and cooling fan. • Life warning information can be output to an external device.	
	Cumulative running hours	• Displays the inverter cumulative running hours, integrated power, cumulative motor running hours, and the number of operation start times. • Outputs the warning when the maintenance time or the number of start times has exceeded the preset value. • Displays the cumulative energy for unit of months, weeks, days and hours and running hours (with RTC).	
	Light-alarm	• WARN. LED is lit and light-alarm factor is displayed.	
	Trip mode	• Displays the cause of trip.	
	Running or trip mode	• Trip history : Saves and displays the cause of the last ten trips (with a code). • Detail data recorded : Saves and displays the detail data recorded on occurrence of the last four trips. • Saves and displays the date, hour and minute with RTC.	
	LED display	• LED for light-alarm or alarm occurrence.	
	Guidance function	• Needed information can be displayed by pushing "HELP" key.	
	Multi language	• Corresponds to Japanese, English, German, French, Spanish, Italian, Chinese, Russian, Greek, Turkish, Polish, Czech, Swedish, Portuguese, Dutch, Malay, Vietnamese, Thai and Indonesian. (soon to correspond to User Customized Language).	
	Battery level display	• Battery level can be displayed when the battery (option) is connected.	
LCD back-light	• Set lighting time for LCD back-light during key operation only or unlit.		
Protective function	Overcurrent protection	• The inverter is stopped for protection against overcurrent.	OC1,OC2,OC3
	Short-circuit protection	• The inverter is stopped for protection against overcurrent caused by a short circuit in the output circuit.	
	Ground fault protection	• The inverter is stopped for protection against overcurrent caused by a grounding fault in the output circuit. (230V series: 25 HP or less, 460V series: 50 HP or less, 575V series: 50 HP or less)	
	Overvoltage protection	• An excessive voltage (230V series: 400 VDC, 460V series: 800 VDC, 575V series: 1000 VDC) in the DC link circuit is detected and the inverter is stopped. If an excessive voltage is applied unintendedly, the protection can not be guaranteed.	OU1,OU2,OU3
	Undervoltage protection	• The voltage drop (230V series: 200 VDC, 460V series: 400 VDC, 575V series: 600 VDC) in the DC link circuit is detected to stop the inverter. However, the alarm will not be issued when the re-starting after instantaneous stop is selected.	LU
	Input phase loss protection	• The input phase loss is detected to protect or shut off the inverter. • When the connected load is small, a phase loss would not be detected.	Lin
Output phase loss detection	• Detects breaks in inverter output wiring at the start of running and during running and stop the inverter output.	OPL	

Items	Specifications	Remarks	
Overheat protection	• Stop the inverter output if expressive cooling fin temperature is detected in case of a cooling fan fault or overload.	OH1	
	• Stop the inverter output if excessive inner temperature of the inverter unit is detected in case of a cooling fan fault or overload. • Stop the inverter output if a failure in the cooling fan is detected. • Stop the inverter output if a fault in the charging circuit is detected.	OH3	
Overload protection	• Stop the inverter output detecting a switching element temperature calculated with cooling fin temperature and the output current.	OLU	
External alarm input	• With the digital input signal (THR), the inverter is stopped with an alarm.	OH2	
Motor protection	Electronic thermal	• The inverter is stopped with an electronic thermal function set to protect the motor. Protects the general-purpose motor and inverter motor over all frequency range. (The level and thermal time constant (0.5 to 75.0 min) can be set.)	OL1
	PTC thermistor	• PTC thermistor input stops the inverter to protect the motor. Connect a PTC thermistor between terminal [C1] and [11] and set the switch on control printed circuit board and the function code.	OH4
	Overload early warning	• Warning signal (OL) is output at the predetermined level set in the electronic thermal function.	—
Memory error	• Data is checked upon power-on and data writing to detect any fault in the memory and stop the inverter if any.	Er1	
Keypad panel communications error	• The keypad panel detects a communication fault between the keypad panel and the inverter main body if the run command is given from the keypad and stops the inverter.	Er2	
CPU error	• Stop the inverter detecting a CPU error or LSI error caused by noise.	Er3	
Option communications error	• When an option is used, a fault of communication with the inverter main body is detected to stop the inverter.	Er4	
Option error	• When an option is used, the option detects a fault to stop the inverter.	Er5	
Operation error	•  key priority : Pressing the  key on the keypad will forcibly decelerate, stop the motor and display "Er6" even if the running command through signal input or communication is selected. • Start check : If the running command is being input when switching the running command method from power-on, alarm reset or the linked operation, the operation starts suddenly. This function prohibits running and displays "Er6".	Er6	
Tuning error	• Stop the inverter output when tuning failure, interruption or any fault as a result of tuning is detected during tuning for motor constant.	Er7	
RS-485 communications error (port1)	• Stop the inverter output if a communication error is detected when the RS-485 port of the keypad panel is used to communicate with a network.	Er8	
Data save error upon undervoltage	• When the undervoltage protection occurred, an alarm is displayed if the data is not properly saved.	ErF	
RS-485 communications error (port2)	• Stop the inverter output if a communication error is detected when the RS-485 port of [DX+]/[DX-] terminals is used to communicate with a network.	ErP	
Hardware error	• Stop the inverter detecting a LSI error on the power printed circuit board caused by noise.	ErH	
Simulation error	• Simulated alarm is output by the keypad panel operation.	Err	
Current input wire break detection	• Stop the inverter detecting an analog wire break detection (enable / disable selectable).	CoF	
PID feedback error detection	• Stop the inverter output detecting a PID feedback line break. (Selectable valid/invalid.)	PV1, PV2, PVA, PVb, PVC	
Customized logic error detection	• Alarm is output detecting a customized logic setting error.	ECL	
Anti jam protection	• Display the error detecting the starting failure due to overcurrent.	rLo	
Filter clogging prevention	• Display the error detecting the overload during PID control.	FoL	
Enable circuit failure detection	• Diagnose the enable circuit condition and stop the inverter output detecting the circuit failure.	ECF	
Ground fault protection	• Detects the zero-phase current in the output power, protects the inverter from overcurrent caused by a ground fault in the output circuit, and stops the inverter. For inverters of: 230V series of 30HP or above, 460V series of 60HP or above and 575V series of 60HP or above.	EF	
Fuse blown	• Detects a break of the main circuit fuse in the inverter and stops the inverter. For inverters of: 230V series of 125HP, 460V series of 150HP or above and 575V series of 200HP or above.	FUS	
Charger circuit error	• Detects a charger circuit error and stops the inverter. For inverters of: 230V series of 30HP or above, 460V series of 60HP or above and 575V series of 60HP or above.	PbF	
DC fan locked	• Failure of the air circulation DC fan inside the inverter. For inverters of: 230V series of 75HP or above (IP00), 30HP or above (IP21) and 7.5HP or above (IP55) 460V series of 150HP or above (IP00), 60HP or above (IP21) and 15HP or above (IP55) 575V series of 200HP or above (IP00), 60HP or above (IP21) and 15HP or above (IP55)	FAL	
Alarm relay output (for any fault)	• The inverter outputs a relay contact signal when the inverter issues an alarm and stops the inverter output. • The alarm stop state is reset by pressing the  key or by the digital input signal (RST).		
Light-alarm (warning)	• Light- alarm is displayed when alarm or warning set as light-alarm is occurred (operation continues). Covered alarms : External alarm (OH2), Inverter overheat (OH3), Motor overheat (OH4), Motor overload (OL1), Keypad panel communication error (Er2), Optional communication error (Er4), Option error (Er5), RS-485 communication error (port 1)(Er8), RS-485 communication error (port 2)(ErP), DC fan lock detected, Overload early warning (for motor), Heatsink overheat early warning, Life early warning (DC link bus capacitor, electrolytic capacitor on printed circuit board, cooling fan), Reference command loss detected, PID warning output, Low torque detected, Thermistor detection (PTC), Machine life (cumulative motor run time error), Machine life (number of startups error), Current Input Wire Break Detection, PID feedback error detection, Low battery warning, Date&time information lost		
Stall prevention	• Operates when the inverter output current is higher than the instantaneous overcurrent limiting level, and avoids tripping, during acceleration and constant speed operation.		
Retry function	• When the motor is tripped and stopped, this function automatically resets the tripping state and restarts operation. (Retry times, waiting time for reset, corresponding trip for retry and retry available time can be set. By using communication the times of the restarting can be monitored).		
Surge protection	• The inverter is protected against surge voltages occurring between the main circuit power line and ground.		
Command loss detected	• A loss (breaking, etc.) of the frequency command is detected to output an alarm and the operation continues at the preset frequency (set at a ratio to the frequency before detection).		
Momentary power failure protection	• If restart upon momentary power failure is selected, the inverter restarts upon recovery of the voltage within the set time.		

*1 Detection of all circuit failures is not guaranteed.

*2 Alarm (ECF) is occurred when one of the inputs of EN1 or EN2 are OFF (if it exceeds 50 ms, it will be as disagreement.). Recycle power supply in order to reset this alarm.

*3 If necessary, connect a digital output of the inverter assigned to function DECF to the reset input of an upper safety relay unit, in order to turn the Enable command OFF and shut down the inverter output.

Items		Specifications	Remarks	
Environment	Installation location	• Free from corrosive gases, flammable gases, dusts, oil mist, direct sunlight. Pollution degree 2 (IEC60664-1). Indoor use only.		
	Ambient temperature	UL TYPE 1	• -10 to +50°C (14 to 122°F) (+50 to +60°C (122 to 140°F) : correspond with de-rating) -10 to +40°C (14 to 104°F) : installed side-by-side without clearance (230V series: 25 HP or less/ 460V series: 50 HP or less/ 575V series: 50 HP or less)	
		UL TYPE 12	• -10 to +40°C (14 to 104°F) (+40 to +50°C (104 to 122°F) : correspond with de-rating) -10 to +30°C (14 to 86°F) : installed side-by-side without clearance (230V series: 25 HP or less/ 460V series: 50 HP or less/ 575V series: 50 HP or less)	
		Open	• -10 to +50°C (140 to 122°F)	
	Ambient humidity	• 5 to 95 %RH (without condensation)		
	Altitude	• 1,000m (3300ft) or lower		
	Vibration	230V series: 60 HP or less/ 460V series: 125 HP or less, 575V series: 150 HP or less 3mm (0.12inch) : 2 to less than 9 Hz 10m/s ² : 9 to less than 200Hz 230V series: 75 to 100 HP 3mm (0.12inch) : 2 to less than 9 Hz 9.8m/s ² : 9 to less than 20Hz 2m/s ² : 20 to less than 55Hz 1m/s ² : 55 to less than 200Hz 230V series: 125 HP/ 460V series: 150 to 1000 HP 575V series: 200 to 300 HP 3mm (0.12inch) : 2 to less than 9 Hz 2m/s ² : 9 to less than 55Hz 1m/s ² : 55 to less than 200Hz		
Storage temperature	• -25 to +70°C (-13 to 158°F)			
Storage humidity	• 5 to 95 %RH (without condensation)			

*1 Detection of all circuit failures is not guaranteed.

*2 Alarm (ECF) is occurred when one of the inputs of EN1 or EN2 are OFF (If it exceeds 50 ms, it will be as disagreement). Recycle power supply in order to reset this alarm.

*3 If necessary, connect a digital output of the inverter assigned to function DECF to the reset input of an upper safety relay unit, in order to turn the Enable command OFF and shut down the inverter output.

How to Read the Model Number

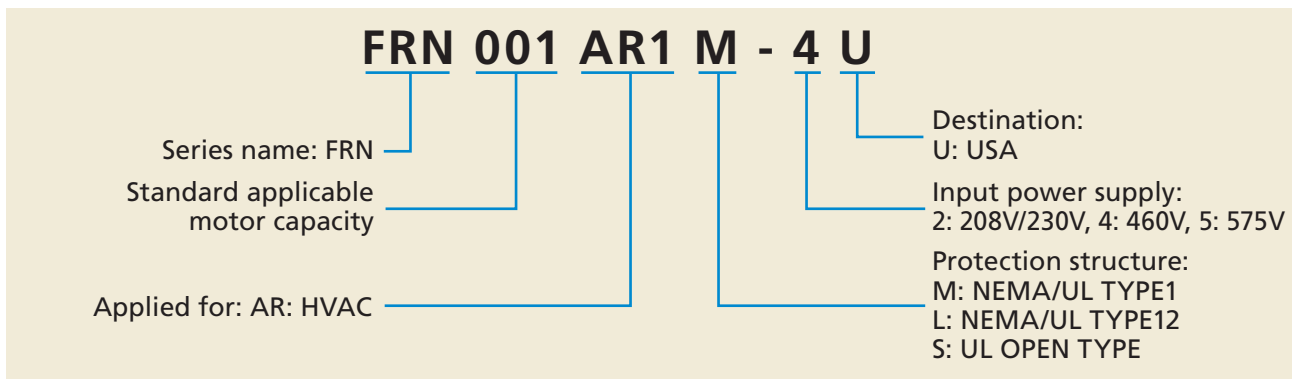

Model Variation

Rated voltage	Nominal applied motor (HP)	Inverter type U	Refer to:	Dimensions unit: mm(inch)											
				W	H	D	D1	D2	W1	W2	H1	H2	H3	M	N
Three-phase 230V	1	FRN001AR1□-2U	Fig.1	150 (5.91)	465 (18.31)	262 (10.31)	162 (6.38)	100 (3.94)	115 (4.53)	17.5 (0.69)	451 (17.76)	7 (0.28)	-	2xφ8 (2xφ0.31)	8 (0.31)
	2	FRN002AR1□-2U													
	3	FRN003AR1□-2U													
	5	FRN005AR1□-2U													
	7	FRN007AR1□-2U													
	10	FRN010AR1□-2U	Fig.2	203 (7.99)	585 (23.03)	262 (10.31)	162 (6.38)	100 (3.94)	158 (6.22)	22.5 (0.89)	571 (22.48)	7 (0.28)	-	2xφ8 (2xφ0.31)	8 (0.31)
	15	FRN015AR1□-2U													
	20	FRN020AR1□-2U													
	25	FRN025AR1□-2U													
	30	FRN030AR1□-2U													
	40	FRN040AR1□-2U	Fig.3	265 (10.43)	736 (28.98)	284 (11.18)	184.5 (7.26)	99.5 (3.92)	180 (7.09)	42.5 (1.67)	716 (28.19)	12 (0.47)	8 (0.31)	2xφ10 (2xφ0.39)	10 (0.39)
	50	FRN050AR1□-2U													
	60	FRN060AR1□-2U													
	75	FRN075AR1S-2U													
	100	FRN100AR1S-2U													
125	FRN125AR1S-2U	Fig.3	355 (13.98)	740 (29.13)	270 (10.63)	115 (4.53)	155 (6.10)	275 (10.83)	40 (1.57)	720 (28.35)	12 (0.47)	8 (0.31)	2xφ10 (2xφ0.39)	10 (0.39)	
530	FRN530AR1S-2U														
750	FRN750AR1S-2U														
285	FRN285AR1S-2U														
145	FRN145AR1S-2U														

Rated voltage	Nominal applied motor (HP)	Inverter type U	Refer to:	Dimensions unit: mm(inch)											
				W	H	D	D1	D2	W1	W2	H1	H2	H3	M	N
Three-phase 460V	1	FRN001AR1□-4U	Fig.1	150 (5.91)	465 (18.31)	262 (10.31)	162 (6.38)	100 (3.94)	115 (4.53)	17.5 (0.69)	451 (17.76)	7 (0.28)	-	2xφ8 (2xφ0.31)	8 (0.31)
	2	FRN002AR1□-4U													
	3	FRN003AR1□-4U													
	5	FRN005AR1□-4U													
	7	FRN007AR1□-4U													
	10	FRN010AR1□-4U	Fig.2	203 (7.99)	585 (23.03)	262 (10.31)	162 (6.38)	100 (3.94)	158 (6.22)	22.5 (0.89)	571 (22.48)	7 (0.28)	-	2xφ8 (2xφ0.31)	8 (0.31)
	15	FRN015AR1□-4U													
	20	FRN020AR1□-4U													
	25	FRN025AR1□-4U													
	30	FRN030AR1□-4U													
	40	FRN040AR1□-4U	Fig.3	265 (10.43)	736 (28.98)	284 (11.18)	184.5 (7.26)	99.5 (3.92)	180 (7.09)	42.5 (1.67)	716 (28.19)	12 (0.47)	8 (0.31)	2xφ10 (2xφ0.39)	10 (0.39)
	50	FRN050AR1□-4U													
	60	FRN060AR1□-4U													
	75	FRN075AR1□-4U													
	100	FRN100AR1□-4U													
	125	FRN125AR1□-4U	Fig.3	530 (20.87)	740 (29.13)	315 (12.40)	135 (5.32)	180 (7.09)	430 (16.93)	50 (1.97)	710 (27.95)	15.5 (0.61)	14.5 (0.57)	2xφ15 (2xφ0.59)	15 (0.59)
	150	FRN150AR1S-4U													
	200	FRN200AR1S-4U													
	250	FRN250AR1S-4U													
	300	FRN300AR1S-4U													
350	FRN350AR1S-4U	Fig.4	680 (26.77)	1000 (39.37)	360 (14.17)	180 (7.09)	180 (7.09)	290 (11.42)	50 (1.97)	970 (38.19)	15.5 (0.61)	14.5 (0.57)	3xφ15 (3xφ0.59)	15 (0.59)	
450	FRN450AR1S-4U														
500	FRN500AR1S-4U														
600	FRN600AR1S-4U														
800	FRN800AR1S-4U														Fig.5
900	FRN900AR1S-4U														
1000	FRN1000AR1S-4U														
1000	FRN1000AR1S-4U														
1000	FRN1000AR1S-4U														

Rated voltage	Nominal applied motor (HP)	Inverter type U	Refer to:	Dimensions unit: mm(inch)											
				W	H	D	D1	D2	W1	W2	H1	H2	H3	M	N
Three-phase 575V	1	FRN001AR1□-5U	Fig.1	150 (5.91)	465 (18.31)	262 (10.31)	162 (6.38)	100 (3.94)	115 (4.53)	17.5 (0.69)	451 (17.76)	7 (0.28)	-	2xφ8 (2xφ0.31)	8 (0.31)
	2	FRN002AR1□-5U													
	3	FRN003AR1□-5U													
	5	FRN005AR1□-5U													
	7	FRN007AR1□-5U													
	10	FRN010AR1□-5U	Fig.2	203 (7.99)	585 (23.03)	262 (10.31)	162 (6.38)	100 (3.94)	158 (6.22)	22.5 (0.89)	571 (22.48)	7 (0.28)	-	2xφ8 (2xφ0.31)	8 (0.31)
	15	FRN015AR1□-5U													
	20	FRN020AR1□-5U													
	25	FRN025AR1□-5U													
	30	FRN030AR1□-5U													
	40	FRN040AR1□-5U	Fig.3	265 (10.43)	736 (28.98)	284 (11.18)	184.5 (7.26)	99.5 (3.92)	180 (7.09)	42.5 (1.67)	716 (28.19)	12 (0.47)	8 (0.31)	2xφ10 (2xφ0.39)	10 (0.39)
	50	FRN050AR1□-5U													
	60	FRN060AR1□-5U													
	75	FRN075AR1□-5U													
	100	FRN100AR1□-5U													
125	FRN125AR1□-5U	Fig.3	300 (11.81)	885 (34.84)	367.9 (14.48)	240.8 (9.48)	127.1 (5.00)	215 (8.46)	50 (1.97)	855 (33.66)	15.5 (0.61)	14.5 (0.57)	2xφ15 (2xφ0.59)	15 (0.59)	
150	FRN150AR1□-5U														
200	FRN200AR1S-5U														
250	FRN250AR1S-5U														
300	FRN300AR1S-5U														

□: M UL Type1
L UL Type12

Outline Drawing

■ Body

Fig.1

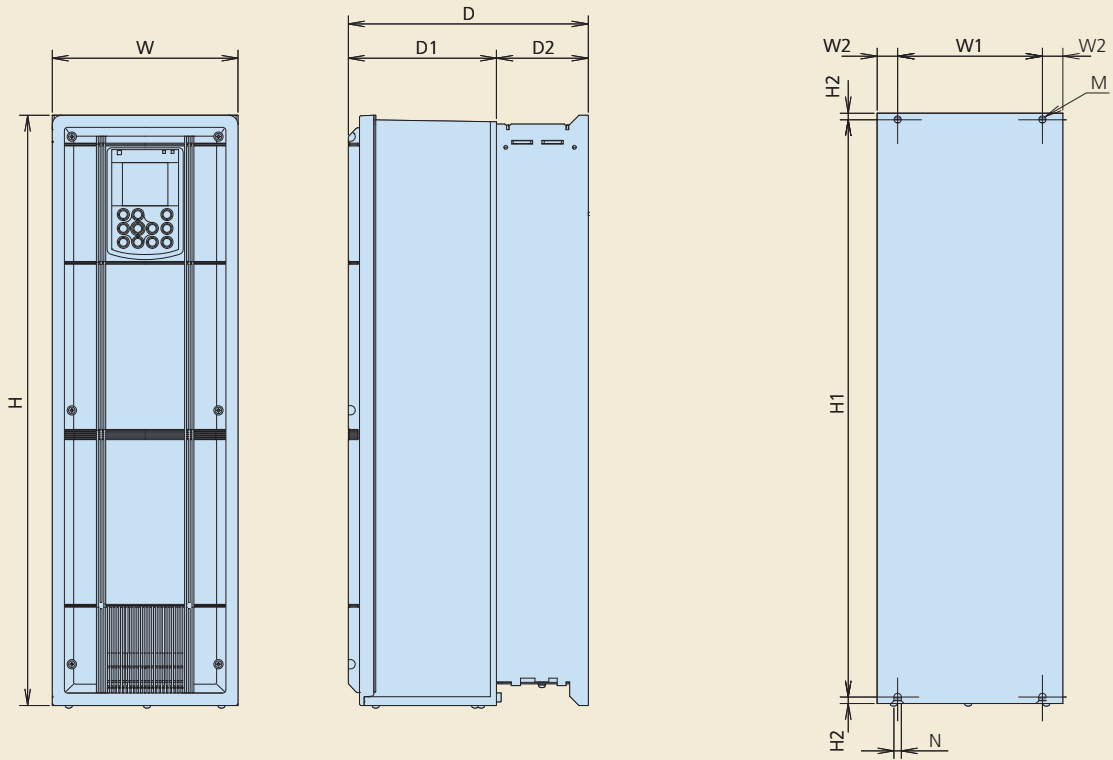

■ Body

Fig.2

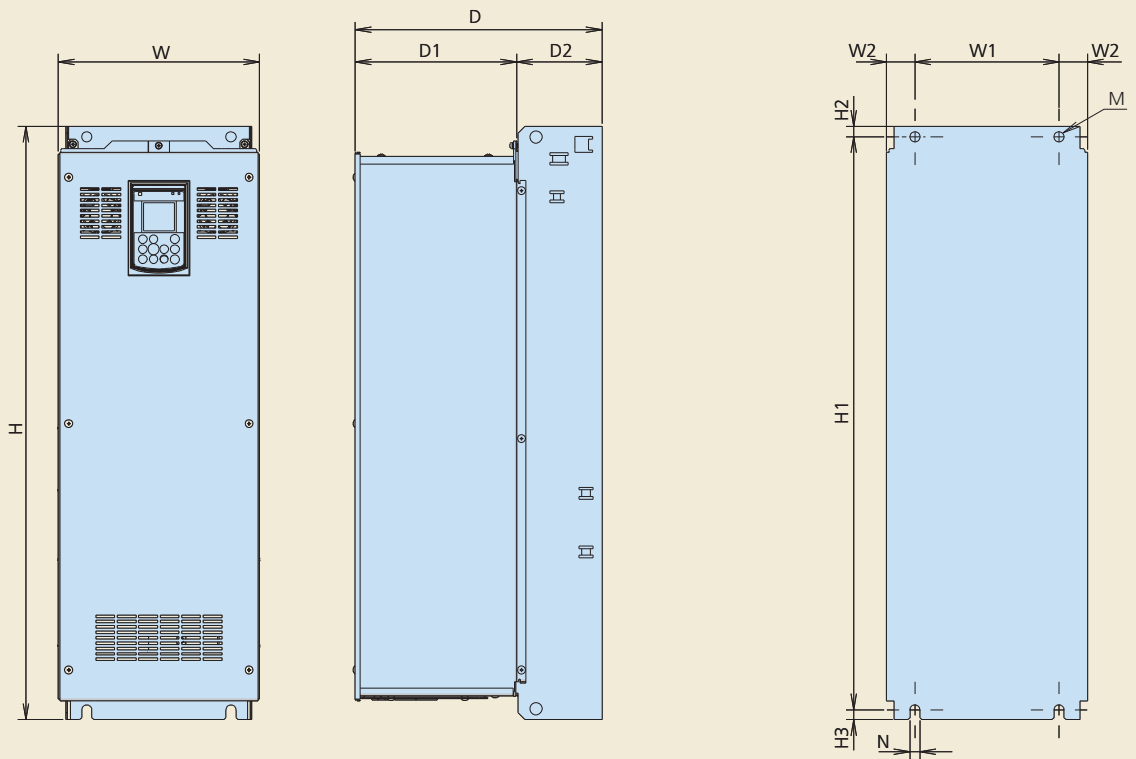

■ Body

Fig.3

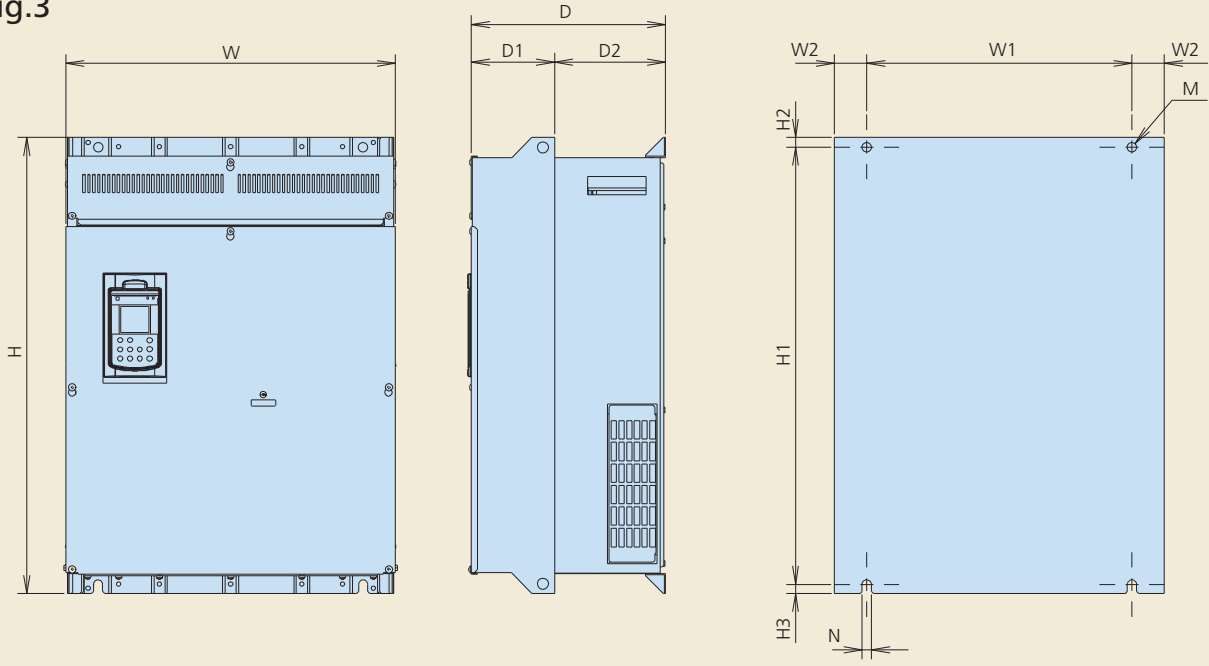

■ Body

Fig.4

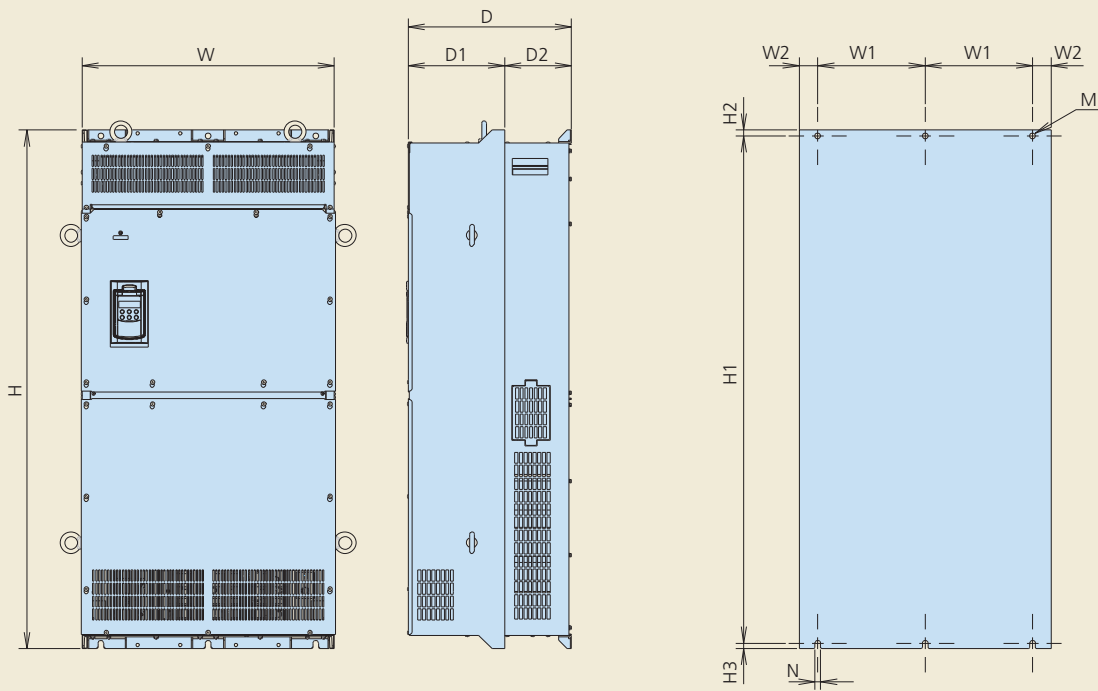

Outline Drawing

Body

Fig.5

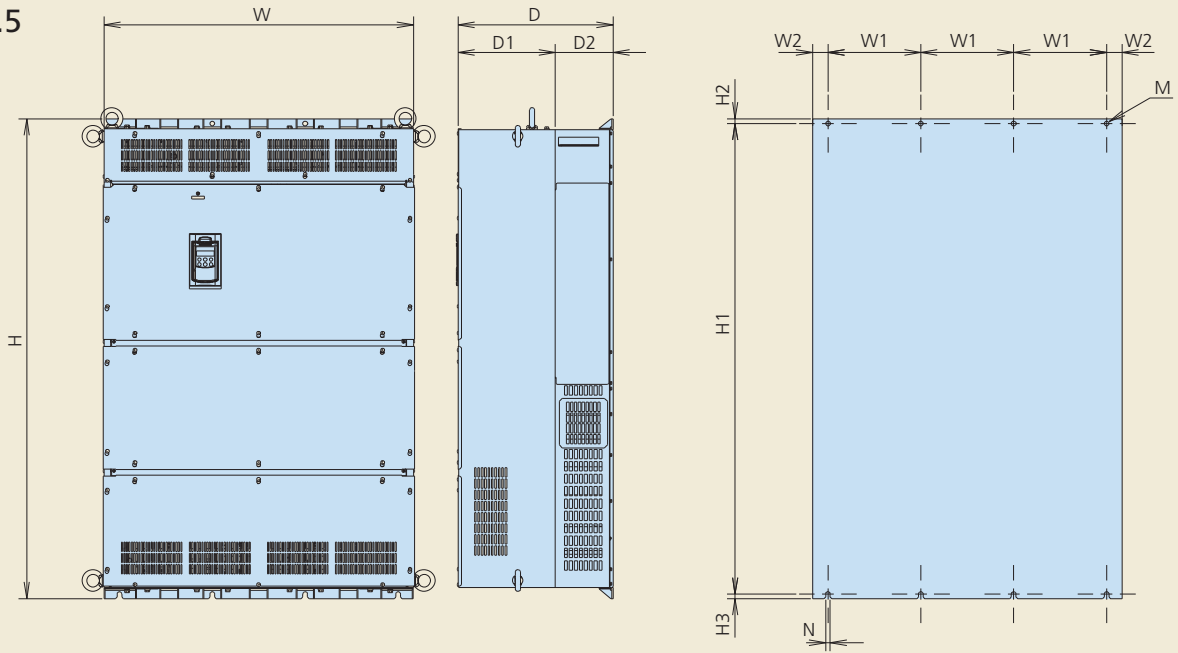

Keypad

[mm(inch)]

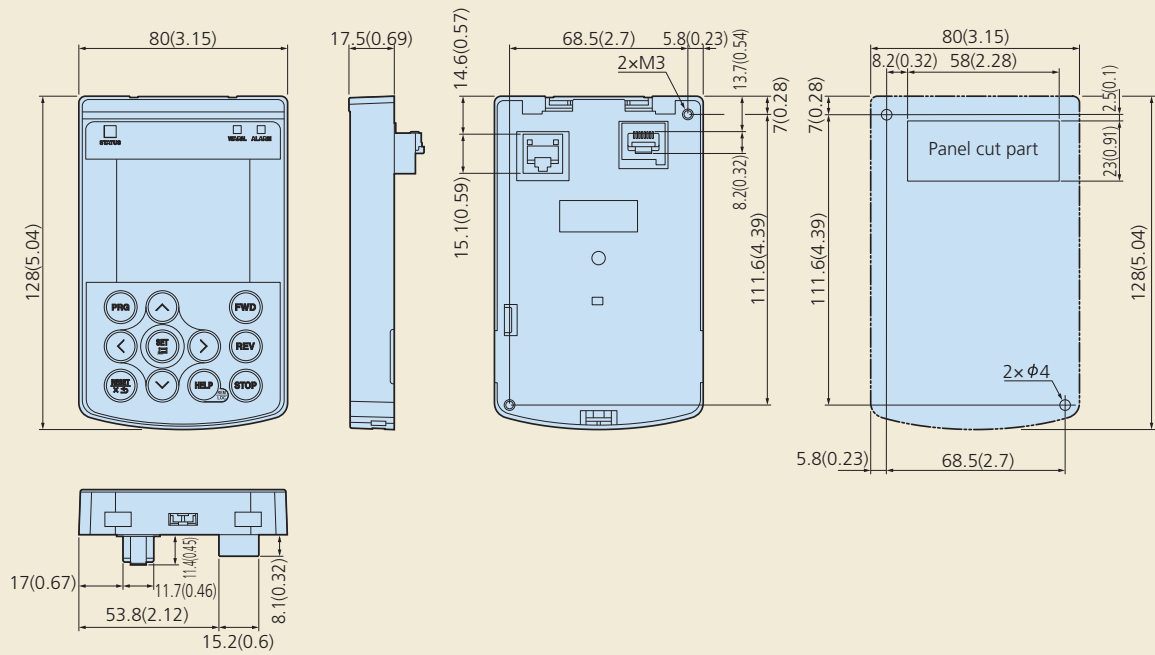

Wiring Diagram

230 V class series inverters of 60 HP or below , 460 V ones of 125 HP or below and 575 V ones of 150 HP or below

SINK mode input with Enable input function used (factory default)

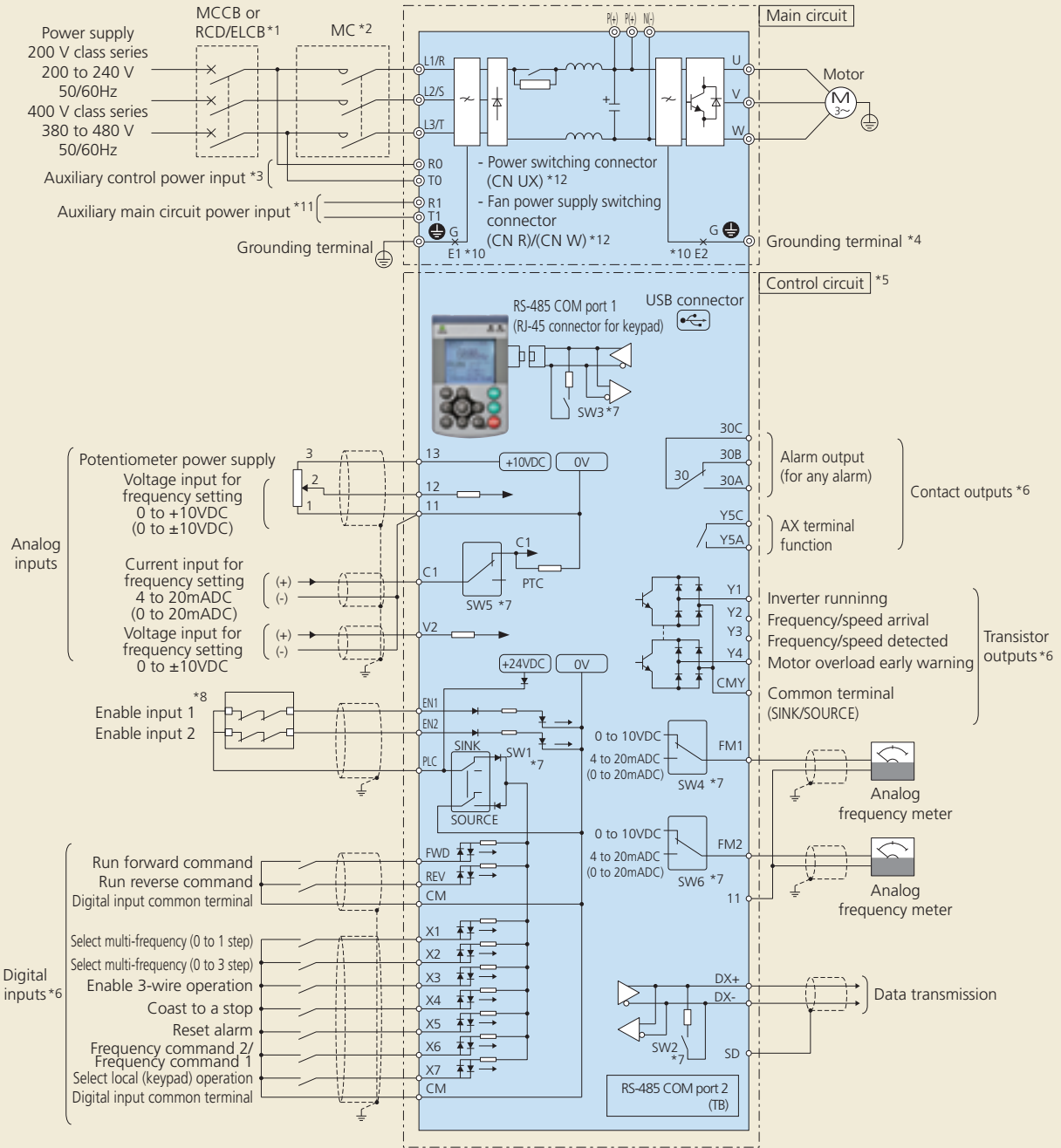

DBR : Dynamic Braking Resistor
 DCR : DC Reactor
 RCD : Residual-current-operated protective device

ELCB : Earth Leakage Circuit Breaker
 MC : Magnetic Contactor
 MCCB : Molded Case Circuit Breaker

Wiring Diagram

230 V class series inverters of 60 HP or below , 460 V ones of 125 HP or below and 575 V ones of 150 HP or below

SOURCE mode input with Enable input function used

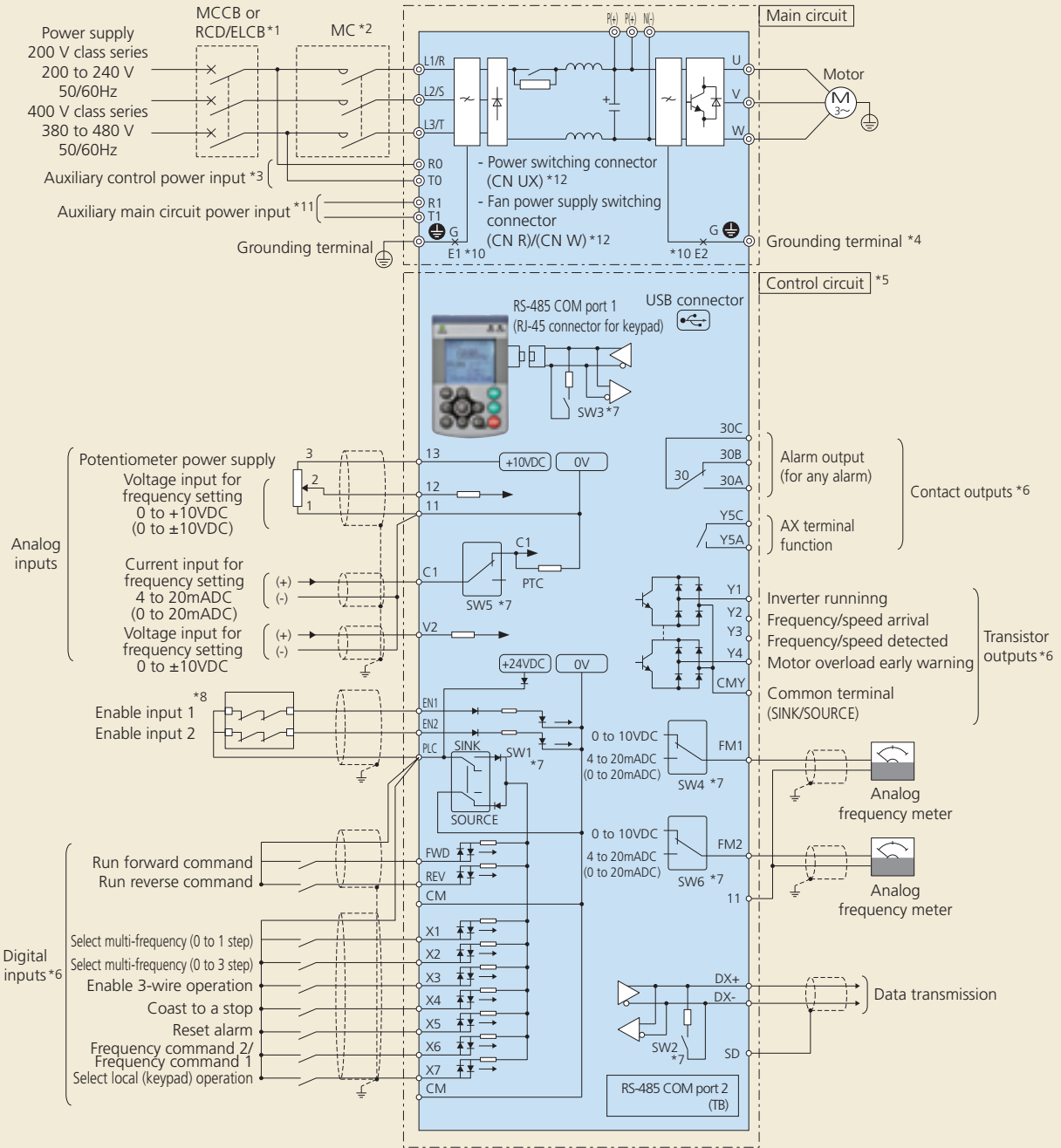

DBR : Dynamic Braking Resistor
DCR : DC Reactor
RCD : Residual-current-operated protective device

ELCB : Earth Leakage Circuit Breaker
MC : Magnetic Contactor
MCCB : Molded Case Circuit Breaker

230 V class series inverters of 75 HP or above , 460 V ones of 150 HP or above and 575 V ones of 200 HP or above

SINK mode input with Enable input function used (factory default)

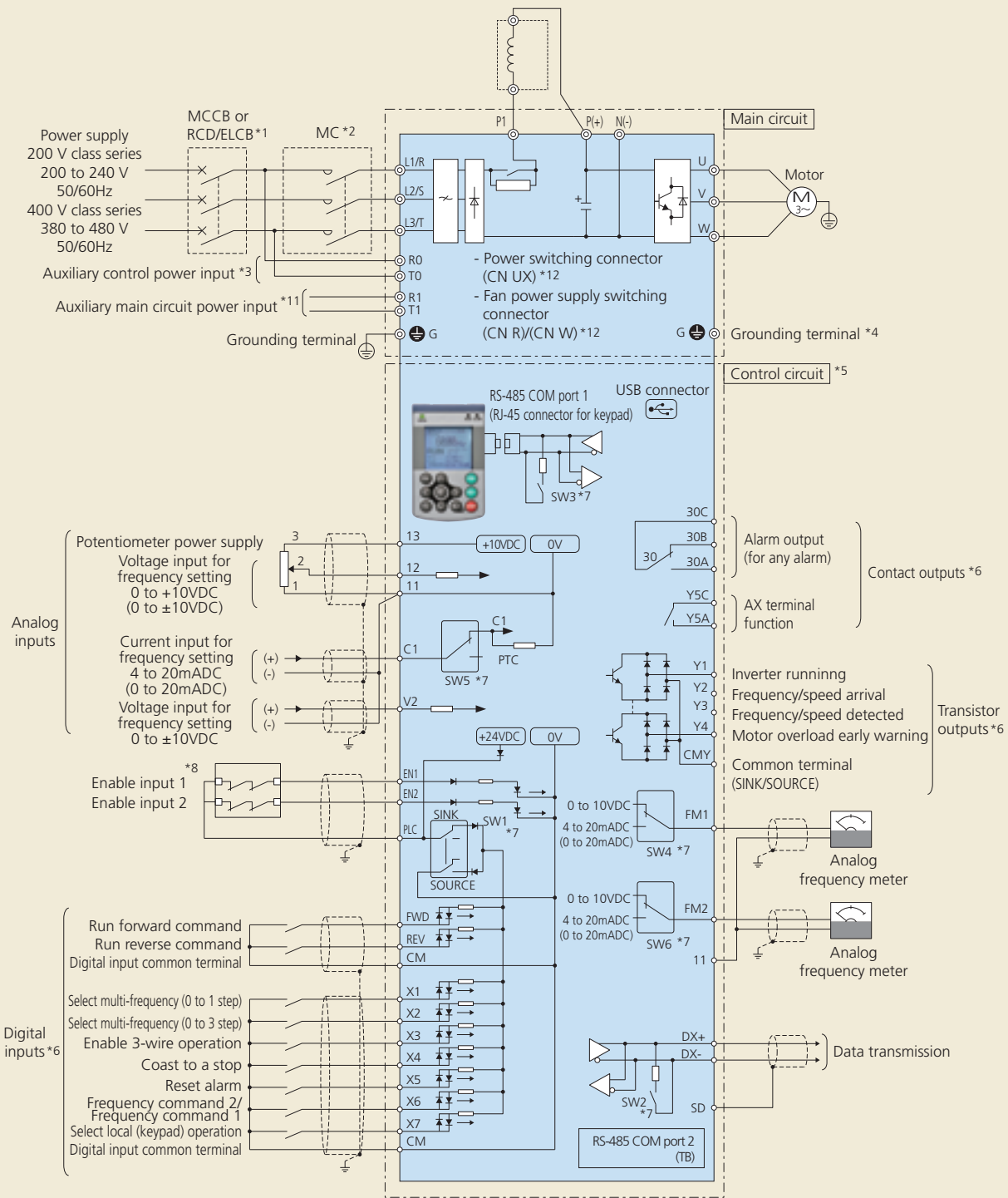

DBR : Dynamic Braking Resistor
 DCR : DC Reactor
 RCD : Residual-current-operated protective device

ELCB : Earth Leakage Circuit Breaker
 MC : Magnetic Contactor
 MCCB : Molded Case Circuit Breaker

Wiring Diagram

230 V class series inverters of 75 HP or above , 460 V ones of 150 HP or above and 575 V ones of 200 HP or above

SOURCE mode input with Enable input function used

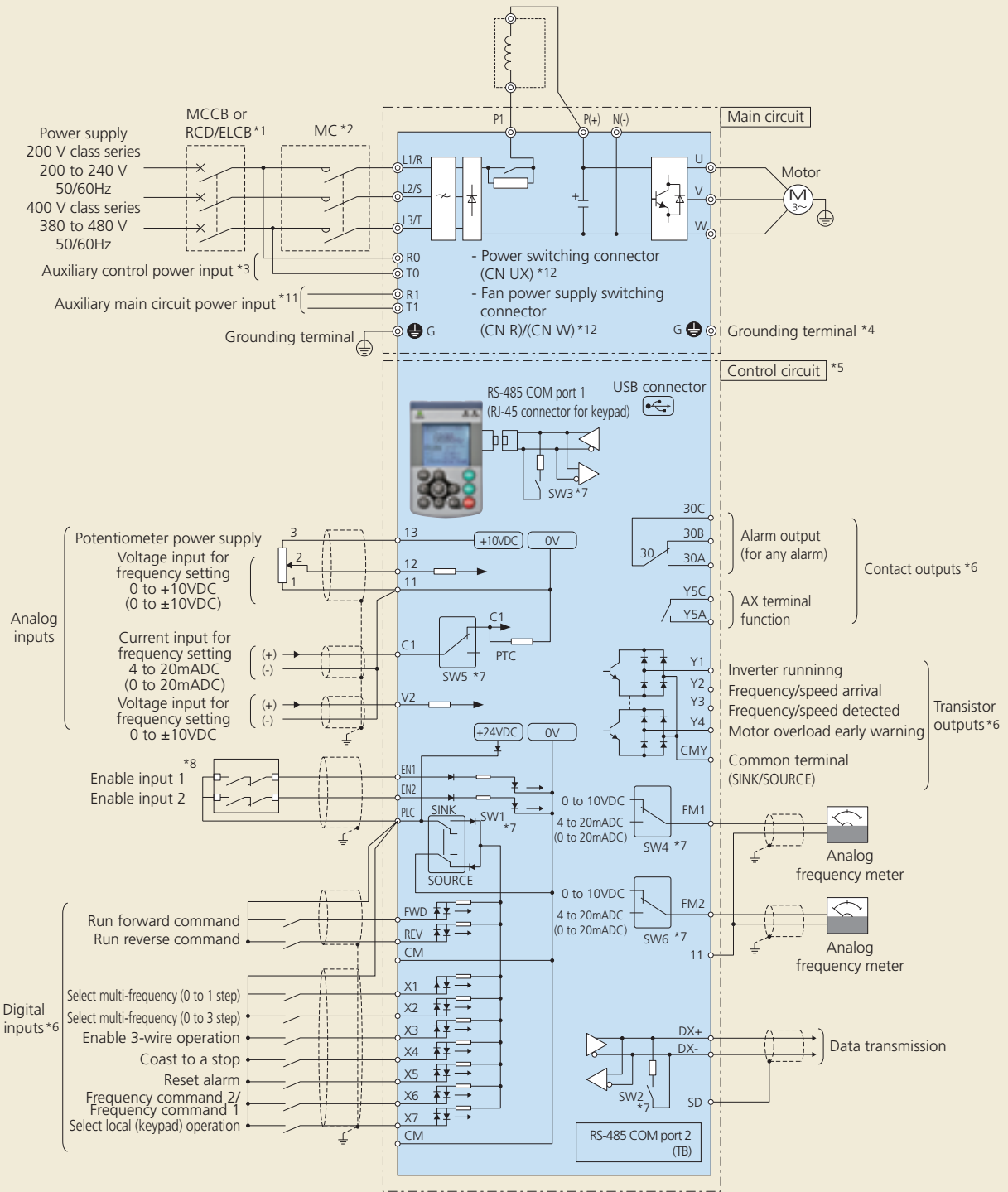

DBR : Dynamic Braking Resistor
 DCR : DC Reactor
 RCD : Residual-current-operated protective device
 ELCB : Earth Leakage Circuit Breaker
 MC : Magnetic Contactor
 MCCB : Molded Case Circuit Breaker

- *1 Install a recommended molded case circuit breaker (MCCB) or residual-current-operated protective device (RCD)/earth leakage circuit breaker (ELCB) (with overcurrent protection function) in the primary circuit of the inverter to protect wiring. Ensure that the circuit breaker capacity is equivalent to or lower than the recommended capacity.
- *2 Install a magnetic contactor (MC) for each inverter to separate the inverter from the power supply, apart from the MCCB or RCD/ELCB, when necessary.
Connect a surge absorber in parallel when installing a coil such as the MC or solenoid near the inverter.
- *3 To retain an alarm output signal ALM issued on inverter's programmable output terminals by the protective function or to keep the keypad alive even if the main power has shut down, connect these terminals to the power supply lines. Even without power supply to these terminals, the inverter can run.
- *4 A grounding terminal for a motor. Use this terminal if needed.
- *5 For control signal wires, use twisted or shielded-twisted wires. When using shielded-twisted wires, connect the shield of them to the common terminals of the control circuit. To prevent malfunction due to noise, keep the control circuit wiring away from the main circuit wiring as far as possible (recommended: 10 cm or more). Never install them in the same wire duct. When crossing the control circuit wiring with the main circuit wiring, set them at right angles.
- *6 The connection diagram shows factory default functions assigned to digital input terminals [X1] to [X7], [FWD] and [REV], transistor output terminals [Y1] to [Y4], and relay contact output terminals [Y5A/C] and [30A/B/C].
- *7 Terminals [Y1] to [Y4] (transistor outputs) support both SINK and SOURCE modes. The diagrams below show the examples of circuit connection between the transistor output of the inverter's control circuit and a PLC.

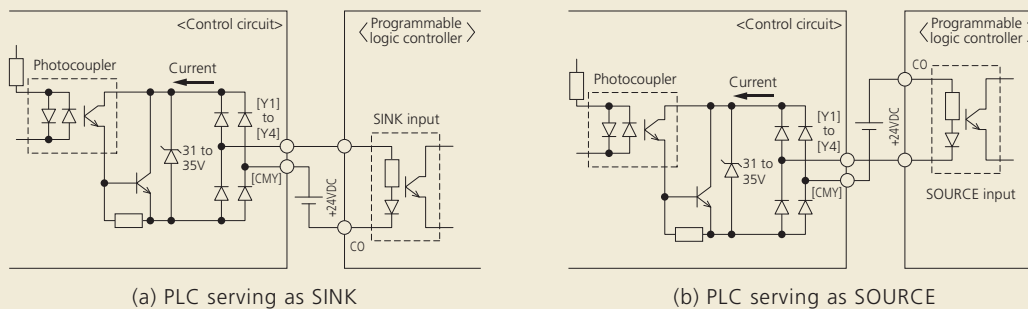

- *8 Slide switches on the control printed circuit board (control PCB). Use these switches to customize the inverter operations. For details, refer to Section 2.3.2 "Setting up the slide switches."
- *9 When the Enable function is not to be used, short-circuit terminals [EN1] and [PLC] and terminals [EN2] and [PLC] using jumper wires. For opening and closing the hardware circuit between terminals [EN1] and [PLC] and between [EN2] and [PLC], use safety components such as safety relays and safety switches. Be sure to use shielded wires exclusive to terminals [EN1] and [PLC] and terminals [EN2] and [PLC]. (Do not put them together with any other control signal wire in the same shielded core.)
- *10 (Missing number for 230 V class series inverters of 75 HP or above , 430 V ones of 150 HP or above and 575 V ones of 150 HP or above.)
Usually there is no need to do anything for the EMC filter.
When the leakage current from the connected EMC filter causes problems with the power supply system, removing screws from terminals [E1] and [E2] could improve the problem. Note that doing so loses the effect of the EMC filter so that the inverter is no longer compliant with the EMC standards. To remove those screws, consult your Fuji Electric representative.
- *11 Usually there is no need to do anything for these terminals. To be used when the inverter is combined with a power regenerative PWM converter (RHC series).
- *12 Main circuit switching connectors. For details, refer to the FRENIC-HVAC Instruction Manual (INR-SI47-1610-E), Chapter 2, Section 2.2.3 "Switching connectors."

Options

Relay Output Interface Card (OPC-RY)

This is an optional card that converts the transistor output at terminals Y1 to Y4 on the inverter body to relay output (1c). Each card has two relay outputs, and four relay outputs are available by installing two cards.

Note: When the card is mounted, the terminals Y1 to Y4 on the inverter body

Relay output: 2 circuits built-in
Signal type: 1c
Contact point capacity: AC250V, 0.3A $\cos\phi=0$.
DC48V, 0.5A (Resistance load)

Relay Output Interface Card (OPC-RY2)

This optional card allows relay outputs (1a) to be added.

* By using the two relay outputs on the inverter body, max. 8 units and one unit (auxiliary pump) can be controlled.

Relay output: 7 circuits built-in
Signal type: 1a
Contact point capacity: AC250V, 0.3A $\cos\phi=0$.
DC48V, 0.5A (Resistance load)

Analog Input Interface Card (OPC-AIO)

This card allows analog input and output to be used.

Analog input: 1 analog voltage input point (0~±10V)
1 analog current input point (4~20mA)
Analog output: 1 analog voltage output point (0~±10V)
1 analog current output point (4~20mA)

Analog Current Output Interface Card (OPC-AO)

This card allows two analog current output (4 to 20mA) points to be used.
The card cannot be used together with OPC-AIO.

CC-Link Communications Card (OPC-CCL)

By connecting this card with the CC-Link master unit, the communications rate up to 10Mbps can be supported and the transmission distance is covered up to 1200m (3900ft) in total.

No. of connection units: 42 units
Communications method: CC-Link Ver1.10 and Ver2.0
Communications rate: 156kbps~

DeviceNet Communications Card (OPC-DEV)

This card enables operation instruction and frequency command to be set from the DeviceNet master, allowing operation conditions to be monitored and all the function codes to be changed and checked.

No. of connection nodes: max. 64 units (including the master unit)
MAC ID: 0~63
Insulation: 500V DC (photocoupler insulation)
Communications rate: 500kbps/250kbps/125kbps
Network consumed power: max. 80mA, 24V DC

PROFIBUS-DP Communications Card (OPC-PDP2)

This card enables operation instruction and frequency command to be set from the PROFIBUS-DP master, allowing operation conditions to be monitored and all the function codes to be changed and checked.

Communications rate: 9.6kbps~12Mbps
Transmission distance: ~1,200m (3900ft)
Connection connector: 2×6-pole terminal block

CANopen Communications Card (OPC-COP)

This card enables operation instruction and frequency command to be set from the CANopen master (such as PC and PLC), allowing all the function codes to be set and checked.

No. of connection nodes: 127 units
Communications rate: 20k, 50k, 125k, 250k, 500k, 800k, 1Mbps
Transmission distance: ~2,500m (8200ft)

LonWorks Communications Card (OPC-LNW)

This card allows peripheral equipment (including a master unit) that is connected via LonWorks to be connected with the inverter, enabling operation instruction and frequency command to be set from the master unit.

Ethernet Communications Card (OPC-ETH)

This interface card allows to connect FRENIC-HVAC to a Ethernet network.

Resistance Temperature Detector Input Card (OPC-PT)

This card can connect FRENIC-HVAC with a mountable two-channel resistance temperature detector (hereinafter-called RTD) to convert temperature values into digital values.
 The following five types of mountable RTD are supported: JPt100, Pt100, Ni100, Pt1000, and Ni1000.

Battery (OPK-BP)

Used to keep the real time clock activated while the inverter power is off. The real time clock can continue to operate even when no power is supplied to the inverter.

Extension Cable for Remote Operation (CB-□S)

This cable is used in connection between the inverter body and the keypad.

Optional type	Length [m(ft)]
CB-5S	5 (16ft)
CB-3S	3 (9.8ft)
CB-1S	1 (3.3ft)



NOTES

When running general-purpose motors

• Driving a 460V general-purpose motor

When driving a 460V general-purpose motor with an inverter using extremely long cables, damage to the insulation of the motor may occur. Use an output circuit filter (OFL) if necessary after checking with the motor manufacturer. Fuji's motors do not require the use of output circuit filters because of their reinforced insulation.

• Torque characteristics and temperature rise

When the inverter is used to run a general-purpose motor, the temperature of the motor becomes higher than when it is operated using a commercial power supply. In the low-speed range, the cooling effect will be weakened, so decrease the output torque of the motor. If constant torque is required in the low-speed range, use a Fuji inverter motor or a motor equipped with an externally powered ventilating fan.

• Vibration

When the motor is mounted to a machine, resonance may be caused by the natural frequencies, including that of the machine. Operation of a 2-pole motor at 60Hz or more may cause abnormal vibration.

* Study use of tier coupling or dampening rubber.

* It is also recommended to use the inverter jump frequency control to avoid resonance points.

• Noise

When an inverter is used with a general-purpose motor, the motor noise level is higher than that with a commercial power supply. To reduce noise, raise carrier frequency of the inverter. High-speed operation at 60Hz or more can also result in more noise.

When running special motors

• Explosion-proof motors

When driving an explosion-proof motor with an inverter, use a combination of a motor and an inverter that has been approved in advance.

• Brake motors

For motors equipped with parallel-connected brakes, their braking power must be supplied from the primary circuit (commercial power supply). If the brake power is connected to the inverter power output circuit (secondary circuit) by mistake, problems may occur.

Do not use inverters for driving motors equipped with series-connected brakes.

• Geared motors

If the power transmission mechanism uses an oil-lubricated gearbox or speed changer/reducer, then continuous motor operation at low speed may cause poor lubrication. Avoid such operation.

• Single-phase motors

Single-phase motors are not suitable for inverter-driven variable speed operation. Use three-phase motors.

Environmental conditions

• Installation location

Use the inverter in a location with an ambient temperature range of -10 to 50°C (14°F to 122°F). The inverter and braking resistor surfaces become hot under certain operating conditions. Install the inverter on nonflammable material such as metal. Ensure that the installation location meets the environmental conditions specified in "Environment" in inverter specifications.

Combination with peripheral devices

• Installing a molded case circuit breaker (MCCB)

Install a recommended molded case circuit breaker (MCCB) or an earth leakage circuit breaker (ELCB) in the primary circuit of each inverter to protect the wiring. Ensure that the circuit breaker capacity is equivalent to or lower than the recommended capacity.

• Installing a magnetic contactor (MC) in the output (secondary) circuit

If a magnetic contactor (MC) is mounted in the inverter's secondary circuit for switching the motor to commercial power or for any other purpose, ensure that both the inverter and the motor are fully stopped before you turn the MC on or off. Remove the surge killer integrated with the MC.

• Installing a magnetic contactor (MC) in the input (primary) circuit

Do not turn the magnetic contactor (MC) in the primary circuit on or off more than once an hour as an inverter fault may result. If frequent starts or stops are required during motor operation, use FWD/REV signals.

• Protecting the motor

The electronic thermal facility of the inverter can protect the general-purpose motor. The operation level and the motor type (general-purpose motor, inverter motor) should be set. For high-speed motors or water-cooled motors, set a small value for the thermal time constant to protect the motor.

If you connect the motor thermal relay to the motor with a long cable, a high-frequency current may flow into the wiring stray capacitance. This may cause the relay to trip at a current lower than the set value for the thermal relay. If this happens, lower the carrier frequency or use the output circuit filter (OFL).

• Discontinuance of power-factor correcting capacitor

Do not mount power factor correcting capacitors in the inverter (primary) circuit. (Use the DC REACTOR to improve the inverter power factor.) Do not use power factor correcting capacitors in the inverter output circuit (secondary). An overcurrent trip will occur, disabling motor operation.

• Discontinuance of surge killer

Do not mount surge killers in the inverter output (secondary) circuit.

• Reducing noise

Use of a filter and shielded wires are typical measures against noise to ensure that EMC Directives are met.

• Measures against surge currents

If an overvoltage trip occurs while the inverter is stopped or operated under a light load, it is assumed that the surge current is generated by open/close of the phase-advancing capacitor in the power system.

We recommend connecting a DC REACTOR to the inverter.

• Megger test

When checking the insulation resistance of the inverter, use a 500V megger and follow the instructions contained in the Instruction Manual.

Wiring

• Wiring distance of control circuit

When performing remote operation, use the twisted shield wire and limit the distance between the inverter and the control box to 20m (65.6ft).

• Wiring length between inverter and motor

If long wiring is used between the inverter and the motor, the inverter will overheat or trip as a result of overcurrent (high-frequency current flowing into the stray capacitance) in the wires connected to the phases. Ensure that the wiring is shorter than 50m (164ft). If this length must be exceeded, lower the carrier frequency or mount an output circuit filter (OFL).

When wiring is longer than 50m (164ft), and sensorless vector control or vector control with speed sensor is selected, execute off-line tuning.

• Wiring size

Select cables with a sufficient capacity by referring to the current value or recommended wire size.

• Wiring type

Do not use multicore cables that are normally used for connecting several inverters and motors.

• Grounding

Securely ground the inverter using the grounding terminal.

Selecting inverter capacity

• Driving general-purpose motor

Select an inverter according to the applicable motor ratings listed in the standard specifications table for the inverter. When high starting torque is required or quick acceleration or deceleration is required, select an inverter with a capacity one size greater than the standard.

• Driving special motors

Select an inverter that meets the following condition: Inverter rated current > Motor rated current.

Transportation and storage

When transporting or storing inverters, follow the procedures and select locations that meet the environmental conditions that agree with the inverter specifications.



UNIVERSAL ELECTRIC MOTORS

DIVISION of 1279311 ONTARIO INC.

TEL: (905)670-3380 FAX: (905)670-7637

TOLL FREE: 1-877-670-3380